

PLC

PL - 250

User Manual

Contents list

1 Acquisition and actuation module PL250A.....	4
1.1 Main features.....	4
1.2 Frontal panel.....	5
1.3 Main hardware data.....	6
1.4 Dimensions and installation.....	8
1.5 Electrical wirings.....	8
1.5.1 Connection of sensors to analog inputs.....	11
1.5.2 Examples of encoders connection.....	11
1.5.3 Example of connection to RS485.....	11
1.6 Setting of internal jumpers.....	12
1.6.1 Jumpers setting for selection of inputs I18-I19-I20 or RS485.....	12
1.6.2 Jumpers setting to select type of analog input AI1.....	13
1.6.3 Jumpers setting to select type of analog input AI2.....	14
1.6.4 Jumpers setting to select type of analog input AI3.....	15
1.6.5 Jumpers setting to select type of analog input AI4.....	16
Examples of inputs configuration for PL250A-x1AD.....	17
1.6.6 Configuration for 1 thermocouple.....	17
1.6.7 Configuration for 2 thermocouples.....	18
1.6.8 Configuration for 1 sensor PT100.....	19
1.6.9 Configuration for 2 sensors PT100.....	20
1.6.10 Jumpers setting to select input I11 or analog output AQ1.....	21
1.6.11 Jumpers setting to select input I12 or analog output AQ2.....	22
1.6.12 Protocol address for PL250A.....	23
1.7 Memory areas of PL250A.....	24
1.7.1 Memory area Variables V.....	24
1.7.2 Memory area “special marker SM”.....	25
1.7.3 Memory area “digital inputs I”.....	36
1.7.4 Memory area “digital outputs Q”.....	36
1.7.5 Memory area “support marker M”.....	36
1.7.6 Area memoria “analog inputs AI”.....	36
1.7.7 Memory area “inputs trimmer TR”.....	36
1.7.8 Memory area “analog outputs AQ”.....	37
1.7.9 Memory area “timer T”.....	37
1.7.10 Memory area “preset timer PT”.....	37
1.7.11 Memory area “counters C”.....	37
1.7.12 Memory area preset values of counters PV.....	37
1.7.13 Memory area EEPROM.....	37
1.7.14 Memory area MMC.....	38
1.7.15 Memory area COMx_SEND and EXP1_SEND.....	38

1.7.16 Memory area COMx_RECEIVE and EXP1_RECEIVE.....	38
1.8 Protocol Modbus RTU slave	39
1.9 Addresses word/bit of PL250A for protocol Modbus RTU	40
2 Ladder programming PL250A.....	43
2.1 General features.....	43
2.2 Elements of Ladder programming.....	43
2.2.1 Contacts digital inputs I.....	43
2.2.2 Relay outputs/SSR/auxiliary Q.....	43
2.2.3 Bistable relays B.....	43
2.2.4 Timer T.....	44
2.2.5 Counters C.....	44
2.2.6 Function Math formules FM	45
2.2.7 Assignement Function MOV.....	45
2.2.8 Assignement Function BLKMOV.....	45
2.2.9 Indexed Assignement Function MOVIND.....	46
2.2.10 Assignement function MOVTEXT	46
2.2.11 Contacts II immediate digital inputs.....	46
2.2.12 Immediate outputs QI.....	46
2.2.13 Contact IF.....	46
2.2.14 Functions SBIT and RBIT.....	47
2.2.15 Contact BIT	47
2.2.16 Function RANGE	47
2.2.17 Contact NOT	48
2.2.18 Contact P and N.....	48
2.2.19 Function SEND and mode Free-port.....	48
2.2.20 Function TunePOS and POS (positioning axis ON/OFF)	49
2.2.21 Function “serial communication COM and EXP”.....	51
2.2.22 Functions StartPID , PID , SetOutPID	51
2.2.23 Functions StartPOSPID and POSPID.....	53
2.2.24 Function GENSET	54
2.2.23 Function CONV	55

1 Acquisition and actuation module PL250A

1.1 Main features

PL250A is a compact PLC for the acquisition of analog and digital signals and the rating of complex mathematical functions. Key features are the logical blocks which allow an easy and quick management of complex operations.

The module may be placed beside the plant to control and remote communication with central unit is possible via RS-485 MODBUS (galvanic isolated), allowing to simplify wirings and to increase noises immunity. The box for DIN rail (9 modules) has been developed in conformity with CE requirements for light and heavy industry.

General features	
Ambient	Operating temperature 0-45 °C, humidity 35..95uR%
Box	9 modules DIN rail, self-exstinguishing material UL94 V0
Sealing	Box IP30
Weight	About 350 gr.
Dimensions	90 x 160, depht 53 mm

The table below summarizes available ordering codes

PL250A-	<input type="checkbox"/>	<input type="checkbox"/>	<input type="checkbox"/>	
Output	1		<input type="checkbox"/> <input type="checkbox"/> 2	12 relays
	2			6 relays + 6 SSR
Resolution analog inputs		0		4 inputs, resolution 10 bit
		1		4 inputs, resolution 16 bit
Supply			AD	12...24V AC/DC \pm 10%

1.2 Frontal panel

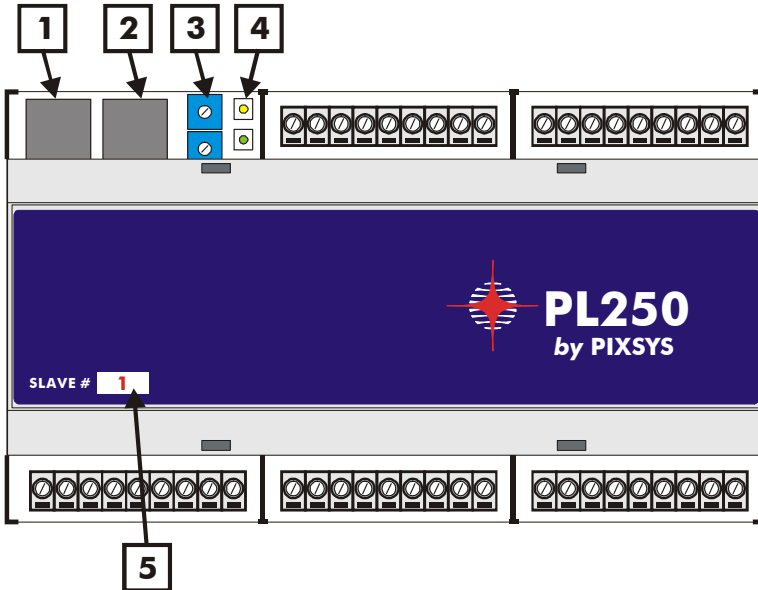

No.	Description
1	COM → Plug connector for serial communication COM1 and COM2
2	EXP → Plug connector for expansion of serial EXP1
3	Trimmer for calibration
4	<p>Green led RUN :</p> <ul style="list-style-type: none"> • ON → PLC is in RUN mode and is executing the instructions programmed by ladder language. • Slowly flashing → (0,5 s on / 0,5 s off) PL250A is used as I/O module (no ladder program loaded) • Fast flashing → (0,2 s on / 0,2 s off) only boot program is loaded on PL250A (no main program and no ladder application) <p>Yellow led COM :</p> <ul style="list-style-type: none"> • ON → for 50mS during transmission of each frame on one of the available serial ports • ON → always during ladder programming or maintenance of PLC (updating main program)
5	Slave number of module PL250A.

1.3 Main hardware data

Hardware		
Supply	12...24 Vac/Vdc 10VA	
Analog inputs (PL250A-x1-AD)	AI1	<ul style="list-style-type: none"> - Tension 0-10V (resolution 10 bit) - Tension 0-1 V (resolution 16 bit) - Tension 0-20 mA (resolution 16 bit) - Current 0-20mA (resolution 16 bit) - Current 4-20mA (resolution 16 bit) - Input PT100, NI100 - Input NPN, PNP¹
	AI2	<ul style="list-style-type: none"> - Tension 0-10V (resolution 10 bit) - Tension 0-1 V (resolution 16 bit) - Tension 0-20 mA (resolution 16 bit) - Current 0-20mA (resolution 16 bit) - Current 4-20mA (resolution 16 bit) - Thermocouples K,S,T,R,J,E - Input compensation PT100, NI100 - Input NPN, PNP¹
	AI3	<ul style="list-style-type: none"> - Tension 0-10V (resolution 10 bit) - Tension 0-1V (resolution 16 bit) - Tension 0-20mV (resolution 16 bit) - Thermocouples K,S,T,R,J,E - Input compensation PT100, NI100 - Input NPN, PNP¹
	AI4	<ul style="list-style-type: none"> - Tension 0-10V (resolution 10 bit) - Tension 0-1V (resolution 16 bit) - Tension 0-20mV (resolution 16 bit) - Cold junction temperature - Input PT100, NI100 - Input NPN, PNP¹

¹ To activate digital input as PNP on PL250A-x1AD connect to the input the signal on pin 3 (OUT+10Vdc) and not the signal on pin 18 (+V) as for the other digital inputs

Analog inputs (PL250A-x0-AD)	AI1÷AI2	- Tension 0-10V (resolution 10 bit) - Current 0-20mA (resolution 8 bit) - Current 4-20mA (resolution 7 bit) - Input PNP, NPN
	AI3÷AI4	- Tension 0-10V (resolution 10 bit) - Input NPN, PNP
Encoder inputs ¹	I5/A1÷I6/B1	- Inputs PNP or 1 st input for bidirectional encoder (30 KHz)
	I7/A2÷I8/B2	- Inputs PNP or 2 nd input for bidirectional encoder (30 KHz)
Digital inputs	I9÷I20	- Inputs PNP
Outputs (PL250A-0xAD)	U1÷U12	- Relay 5A-230 Vac
Outputs (PL250A-1xAD)	U1÷U6	- Relay 5A-230 Vac
	U7÷U12	- Outputs SSR 10-32Vdc max 100mA for output
Analog outputs ²	AQ1÷AQ2	- Tension 0-10V (resolution 8 bit)
Serial ports	COM1	- RS485 available on terminal block ³ (A,B,C) and on COM plug-8 poles (galvanic isolated).
	EXP1	- RS232 available on connector EXP plug-8 poles (not isolated).
	COM2	- RS232 available by connector COM plug-8 poles (not isolated).

¹ First encoder input uses hardware inputs I5 and I6. Second encoder input uses hardware inputs I7 and I8. If encoder inputs are used, the relevant digital inputs are not available. Max. frequency for encoders is 30 KHz if not used contemporarily, 15 KHz if both inputs are used contemporarily.

² To use analog outputs, select internal jumpers which disconnect from terminal block the inputs I11 and I12. Therefore these inputs cannot be used.

³ To get COM1 RS485 on pins A, B, C select properly the internal jumpers which disconnect inputs I18, I19 and I20. Therefore these inputs cannot be used.

1.4 Dimensions and installation

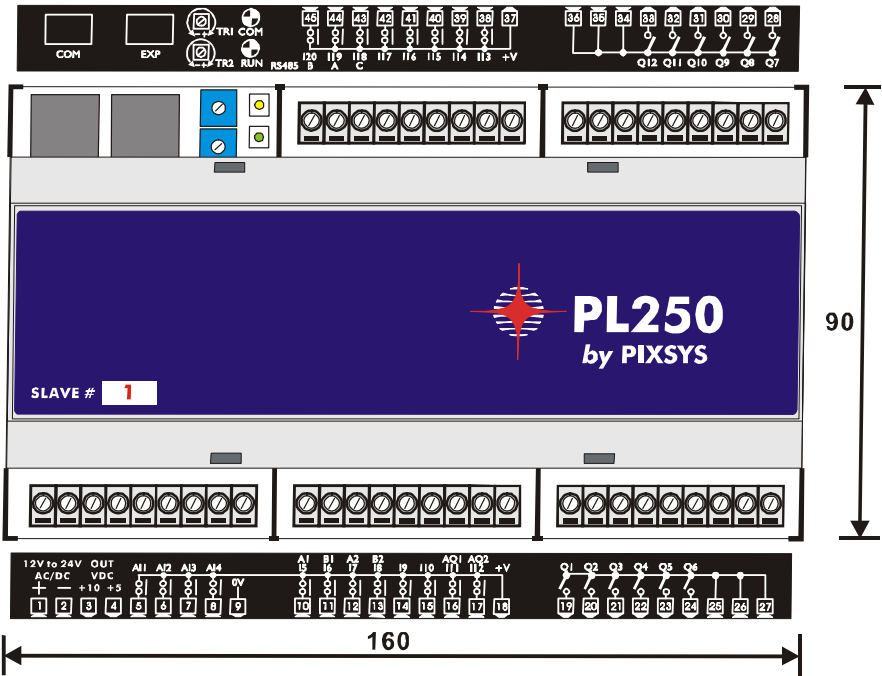

Guida DIN EN 50022 Materiale Noryl UL 94 V-0 Peso 350 gr.

1.5 Electrical wirings

No.	Name	Description
1	+	Supply 12÷24V AC/DC 10VA. To improve noises immunity, the secondary of dedicated transformer is highly recommended
2	-	
3	OUT 10Vdc	Output 10 Vdc for supply of sensors, potentiometers, encoders .. (reference signal on pin 9) Output current: 100 mA max @ 12 Vac/Vdc (supply) 50 mA max @ 24 Vac/Vdc (supply)

4	OUT 5 Vdc	Output 5 Vdc for supply of sensors, potentiometers, encoders .. (reference signal on pin 9) Output current: 100 mA max		
5	AI1	Positive signal Analog input AI1.		
6	AI2	Positive signal Analog input AI2.		
7	AI3	Positive signal Analog input AI3.		
8	AI4	Positive signal Analog input AI4.		
9	0V	Common negative signal for analog inputs. Connect this signal to analog inputs AI1÷AI4 selected as digital inputs NPN to activate the input.		
18	V+	Common positive signal for digital inputs. Connect this signal to one of the digital inputs I5÷I20 or to analog inputs AI1÷AI4 selected as digital inputs PNP to activate the input. Signal available on these pins can supply sensors (current/tension) to connect to the analog inputs (Warning: on these pins the available tension is Vcc, not stabilized!).		
37				
10	I5 / A1	Digital input	Input bidirectional encoder no. 1	
11	I6 / B1	Digital input.		
12	I7 / A2	Digital input.	Input bidirectional encoder no. 2	
13	I8 / B2	Digital input.		
14	I9	Digital input.		
15	I10	Digital input.		
16	I11 / AQ1	Digital input / Analog output AQ1 0÷10VDC. (See 1.6.6)		
17	I12 / AQ2	Digital input / Analog output AQ2 0÷10VDC. (See 1.6.7)		
38	I13	Digital input.		
39	I14	Digital input.		
40	I15	Digital input.		
41	I16	Digital input.		
42	I17	Digital input.		
43	I17 / C	Digital input.	Serial COM1-RS485 (See 1.6.1)	
44	I19 / A	Digital input.		
45	I20 / B	Digital input.		
19	Q1 N.O.	Relay contact Q1 N.O.		
20	Q2 N.O.	Relay contact Q2 N.O.		
21	Q3 N.O.	Relay contact Q3 N.O.		
				To activate digital inputs, shortcircuit signal V+ on the pin of input
				5A ÷ 230Volt resistive

22	Q4 N.O.	Relay contact Q4 N.O.	
23	Q5 N.O.	Relay contact Q5 N.O.	
24	Q6 N.O.	Relay contact Q6 N.O.	
25	Q1÷Q6 Com	Common contact for relays Q1÷Q6.	
26			
27			
28	Q7 N.O.	Relay contact Q7 N.O.	5A ÷ 230Volt resistive PL250-1xAD 10-32V 100mA for PL250-2xAD
29	Q8 N.O.	Relay contact Q8 N.O.	
30	Q9 N.O.	Relay contact Q9 N.O.	
31	Q10 N.O.	Relay contact Q10 N.O.	
32	Q11 N.O.	Relay contact Q11 N.O.	
33	Q12 N.O.	Relay contact Q12 N.O.	
34	Q7÷Q12 Com	Common contact for relays Q7÷Q12.	
35			
36			

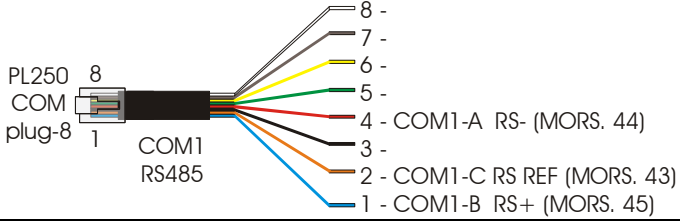
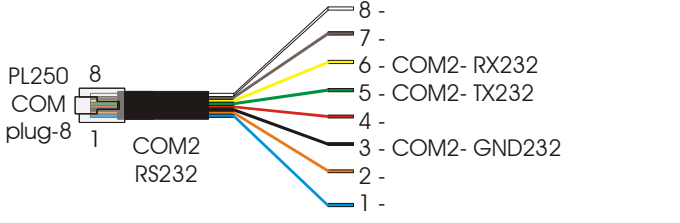
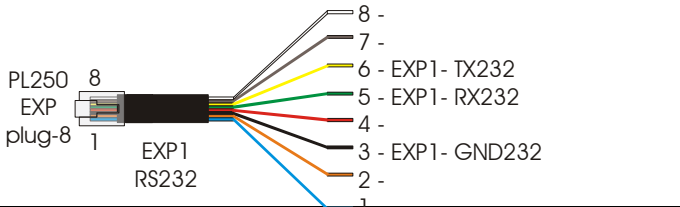
No.	Name	Description
COM	COM1 RS485	 <p>PL250 COM plug-8</p> <p>8 7 6 5 4 - COM1-A RS- (MORS. 44) 3 2 - COM1-C RS REF (MORS. 43) 1 - COM1-B RS+ (MORS. 45)</p> <p>COM1 RS485</p>
	COM2 RS232	 <p>PL250 COM plug-8</p> <p>8 7 6 - COM2- RX232 5 - COM2- TX232 4 3 - COM2- GND232 2 1</p> <p>COM2 RS232</p>
EXP	EXP1 RS232	 <p>PL250 EXP plug-8</p> <p>8 7 6 - EXP1- TX232 5 - EXP1- RX232 4 3 - EXP1- GND232 2 1</p> <p>EXP1 RS232</p>

1.5.1 Connection of sensors to analog inputs

Below some examples of connection for common sensors to the analog inputs of PL250A.

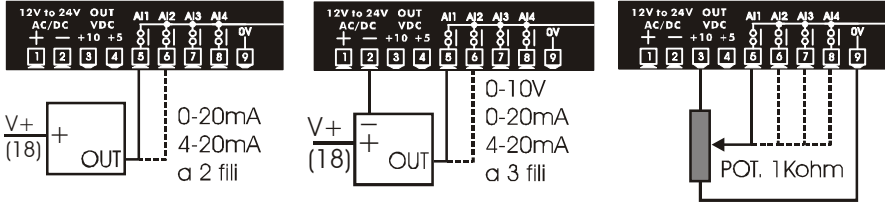

1.5.2 Examples of encoders connection

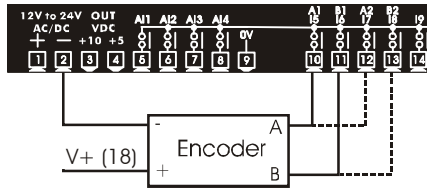

1.5.3 Example of connection to RS485

Below an example of connection for more modules PL250A to RS485 for communication with a master device.

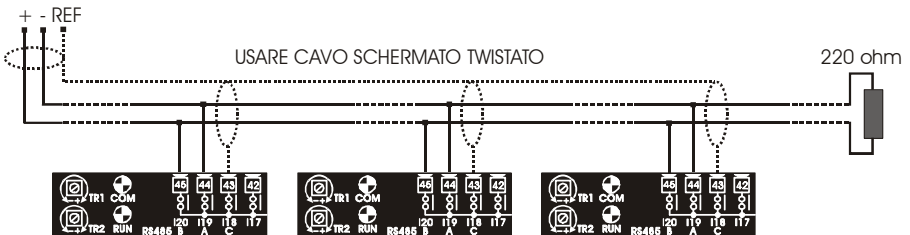

1.6 Setting of internal jumpers

PL250A is provided with some internal jumpers which allow to configure analog inputs, to connect the pins to the analog outputs or to RS485 available on Plug-8 COM1.

WARNING: Switch off the PL250A before proceeding with any hardware configuration !

Jumper JP16 is not available on model PL250A-x0AD, even if it is marked on drawings

1.6.1 Jumpers setting for selection of inputs I18-I19-I20 or RS485

Pins 43, 44 and 45 may assume different functions, selectable by internal jumpers. To enable the chosen function, select jumpers as described :

- Digital inputs I18, I19 and I20 (JP17, JP2 and JP3 closed between 2-3)

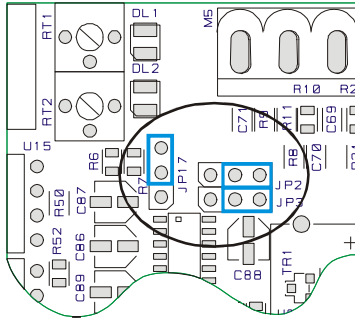

- Serial COM1 for expansion and connection to bus RS485 (JP17, JP2 and JP3 closed between 1-2)

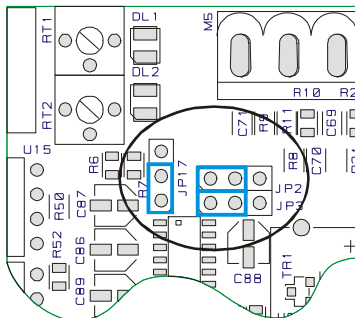

1.6.2 Jumpers setting to select type of analog input AI1

Select the jumpers as shown to get the chosen type of input:

- Analog input 0÷10V or Digital input PNP (input 0÷20mV and 0÷1V only for PL250A-x1AD) (JP4 and JP6 open)

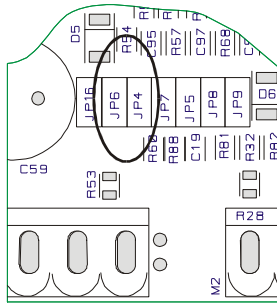

- Analog input 0÷20mA or 4÷20mA (JP4 closed and JP6 open)

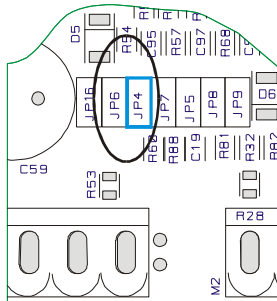

- Digital input NPN (JP4 open and JP6 closed)

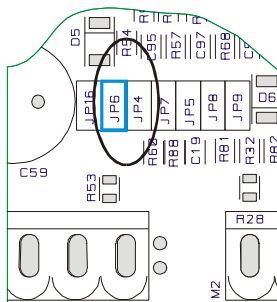

1.6.3 Jumpers setting to select type of analog input AI2

Select the jumpers as shown to get the chosen type of input:

- Analog input 0÷10V or Digital input (input 0÷20mV and 0÷1V only on version PL250A-x1AD) (JP5 and JP7 open)

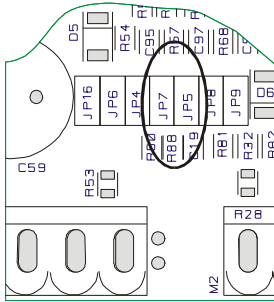

- Analog input 0÷20mA or 4÷20mA (JP5 closed and JP7 open)

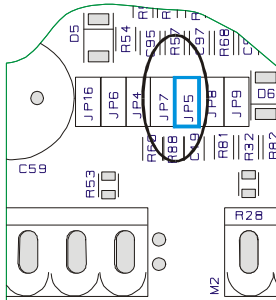

- Digital input NPN (JP5 open and JP7 closed)

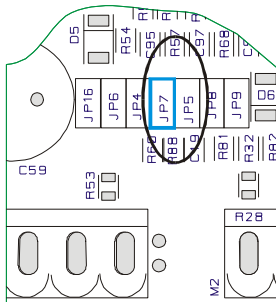

1.6.4 Jumpers setting to select type of analog input AI3

Select the jumpers as shown to get the chosen type of input:

- Analog input 0÷10V or Digital input PNP (input 0÷20mV and 0÷1V only on version PL250A-x1AD) (JP8 open)

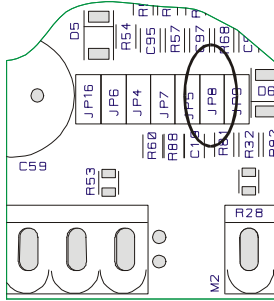

- Digital input NPN (JP8 closed)

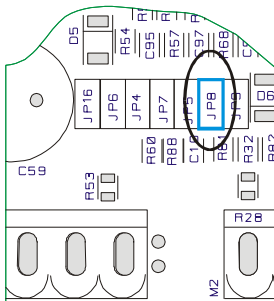

1.6.5 Jumpers setting to select type of analog input AI4

Select the jumpers as shown to get the chosen type of input:

- Analog input 0÷10V or Digital input PNP (input 0÷20mV and 0÷1V only for PL250A-x1AD) (JP9 open)

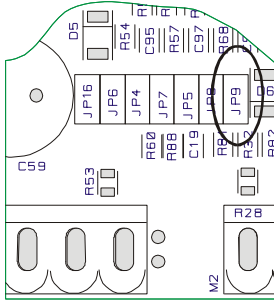

- Digital input NPN (JP9 closed)

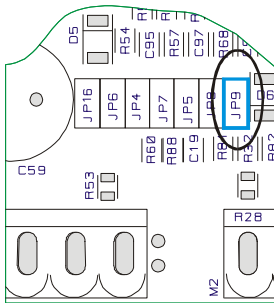

Examples of inputs configuration for PL250A-x1AD

1.6.6 Configuration for 1 thermocouple

- 0V common input thermocouples. Connect negative pole of thermocouple to this input.
- AI3 thermocouple (JP8 closed)
Connect positive pole of thermocouple to this input.
- AI4 temperature of cold junction (JP9 closed and JP16 closed)
Used by internal device. Do not use this input.
- AI1 and AI2 available for other configurations

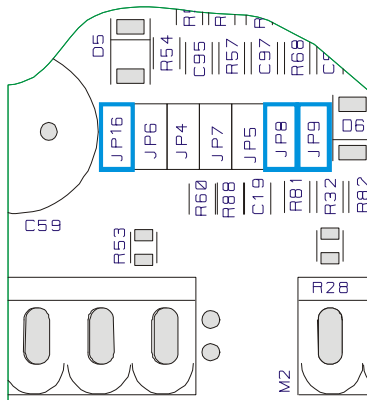

1.6.7 Configuration for 2 thermocouples

- 0V common inputs thermocouples. Connect negative poles of thermocouples to this input.
-
- AI2 thermocouple no. 1 (JP7 closed and JP5 open)
Connect positive pole of 1st thermocouple to this input.
- AI3 thermocouple no. 2 (JP8 closed)
Connect positive pole of 2nd thermocouple to this input.
- AI4 temperature of cold junction (JP9 closed and JP16 closed)
Used by internal device. Do not use this input.
- AI1 available for other configurations

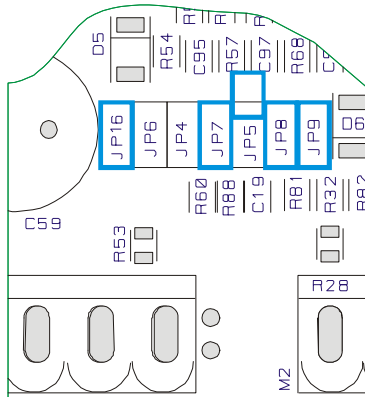

1.6.8 Configuration for 1 sensor PT100

- AI3 compensation PT100 (JP8 open)
Connect to this input the compensation cable of PT100 (one of the two wires with same colour for PT100 – 3 wires)
- AI4 input PT100 (JP9 closed and JP16 open)
Connect positive pole of PT100 to this input.
(one of the two wires with same colour for PT100 – 3 wires)
- Connect 3rd wire of PT100 to ground pin
- AI1 and AI2 available for other configuration

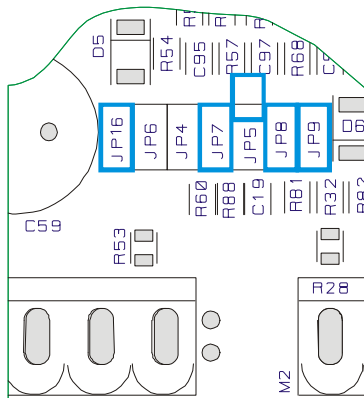

1.6.9 Configuration for 2 sensors PT100

- AI1 input PT100 no. 1 (JP6 closed and JP4 open)
Connect to this input the positive of PT100 (one of the two wires with same colour for PT100 – 3 wires)
- AI2 compensation PT100 no. 1 (JP5 open and JP7 open)
Connect to this input the compensation cable of PT100 (one of the two wires with same colour for PT100 – 3 wires)
- AI3 compensation PT100 no. 2 (JP8 open)
Connect to this input the compensation cable of PT100 (one of the two wires with same colour for PT100 – 3 wires)
- AI4 input PT100 no. 2 (JP9 closed and JP16 open)
Connect to this input the positive of PT100 (one of the two wires with same colour for PT100 – 3 wires)
- Connect third wire of PT100 to ground pin

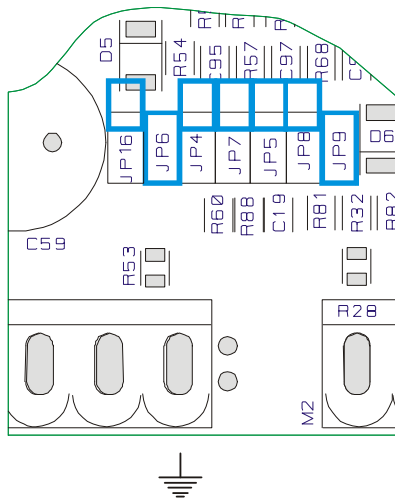

1.6.10 Jumpers setting to select input I11 or analog output AQ1

N.B.: configurations valid also for PL250A-x0AD

Pin 16 can assume a double function, selectable by internal jumper. To get the chosen function, select the jumpers as described:

- Analog output AQ1 (JP12 closed between 2-3)

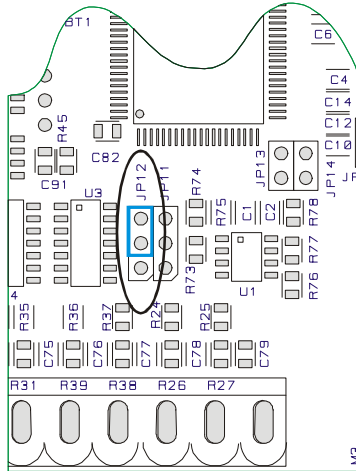

- Digital input I11 (JP12 closed between 1-2)

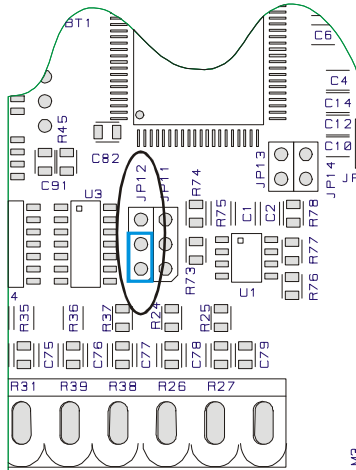

1.6.11 Jumpers setting to select input I12 or analog output AQ2

Pin 17 can assume a double function, selectable by internal jumper. To get the chosen function, select the jumpers as described:

- Analog output AQ2 (JP11 closed between 2-3)

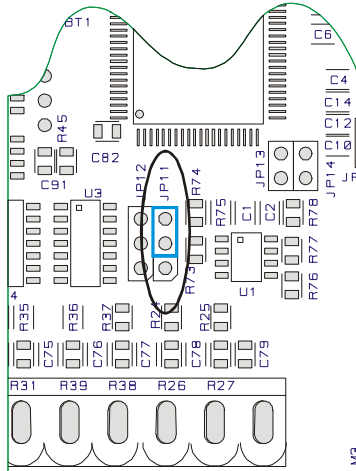

- Digital input I12 (JP11 closed between 1-2)

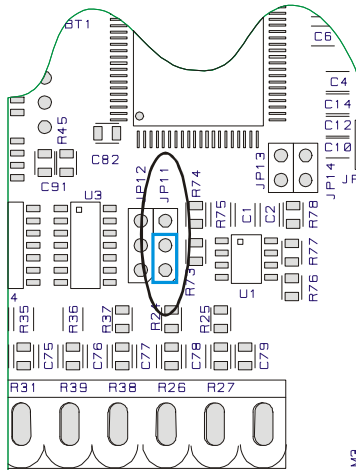

1.6.12 Protocol address for PL250A

Two jumpers are provided to configure the address of module for serial communication with a master device. There are 4 available combinations of these jumpers. To connect more than 4 modules to the same network, it is necessary to change the offset value of address. The address is given as follows:

MODULE ADDRESS = ADDRESS OFFSET + JUMPERS COMBINATION

The address offset, which is a value stored on memory of PL250A (default =“1”), can be modified by writing on Word SM82.

Jumpers combinations are the following:

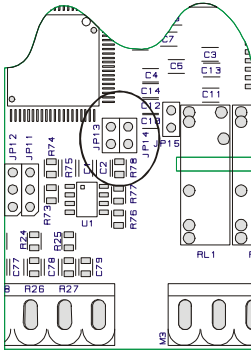

Combination jumper = 0

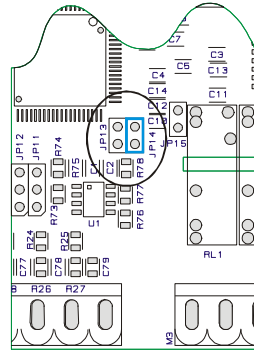

Combination jumper = 1

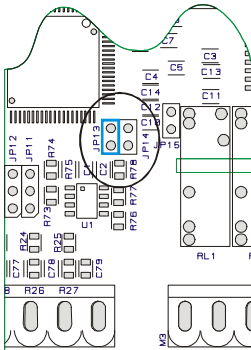

Combination jumper = 2

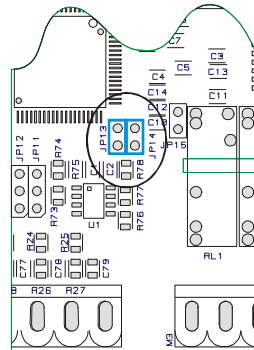

Combination jumper = 3

1.7 Memory areas of PL250A

On module PL250A the user can enter memory areas for reading and/or writing of program data. Memory areas can be entered by instructions which enter single bit (B), by word (W) or double word (D).

Code	Location	ENTER BY
V	Area Variables V	B, W, D
SM	Area Special Marker	B, W, D
I	Area Digital inputs	B, W
AI	Area Analog inputs	B, W
Q	Area Digital outputs	B, W
M	Area Marker	B, W
AQ	Area Analog outputs	B, W
T	Area Timer	B, W
PT	Area Preset Timer	B, W
C	Area Counters	B, W
PV	Area Preset Conters	B, W
EEP	Area EEPROM	W

1.7.1 Memory area Variables V

The memory area “Variables V” is the retaining memory which is used by the program to store data of operations. It is composed by 200 locations, type word (therefore 100 double words). This area may be entered by operations on bit, word or double word. Number of double word still refers to the words structure, therefore to enter consecutive variables in double word the number must be put forward of 2 units. The values are stored also in case of power fail thanks to rechargeable back-up battery. After having been charged, the battery stores data for approx. 6 months.

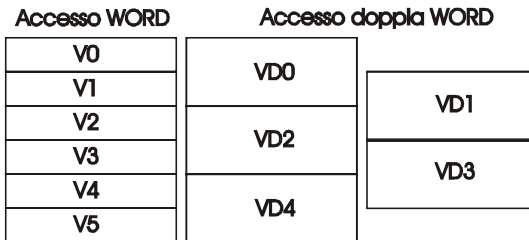

1.7.2 Memory area “special marker SM”

This area is the retaining memory which contains all data used by the ladder program to interact with the hardware resources of PL250. Some of these data are initialized at starting of PLC with default values described in the table below. This area contains all data related to analog inputs, trimmers, countings and set values of encoders, and also some bits controlled by the PLC for the ladder application as well as the settings for serial ports.

The table below includes the content of each single location of the are “Special markers”, giving the address for Modbus protocol and the type of operation allowed for each location (R=reading, W=writing, R/W=reading/writing).

SM n°	Mod. word	Description / Meaning	
SM0	2000	Status bit	
	Bit 0	RUN/STOP bit (1=run). At starting this bit is always forced to ON, obtaining the RUN mode of PLC. In STOP mode, the relay outputs of PLC are disabled.	R/W
	Bit 1	This bit is always ON for first scanning cycle of main program. Ex. It is used to execute initialization subprogram.	R
	Bit 2	This bit makes available a clock impulse of 60 seconds (ON for 30 seconds, OFF for 30 seconds).	R
	Bit 3	This bit makes available a clock impulse of 1 second (ON for 0,5 second, OFF for 0,5 second)	R
	Bit 4	This bit è a clock of scanning cycle, which is active ON for one cycle and disabled OFF for following cycle. It may be used as counting input for scanning cycle.	R
	Bit 5	Bit TEST. Setting this bit as ON, the reading of digital inputs is disabled. Status of inputs is read on words SM8 and SM9. Setting these words, it is possibile to execute debug/test of program simulating the starting.	R/W
	Bit 6	This bit is ON during the transmission of data to serial port COM1. It is automatically set to OFF at the end of transmission	R
	Bit 7	This bit is ON during the transmission of data to serial port EXP1. It is automatically set to OFF at the end of transmission.	R

Bit 8	This bit is ON during the transmission of data to serial port COM2. It is automatically set to OFF at the end of transmission.	R
Bit 9	If set to ON this bit enables mode “modem” for serial port COM1. This means that Timeout between one character and the other character in receiving mode is automatically set to 40mS.	R/W
Bit 10	If set to ON this bit enables mode “modem” for serial port EXP1. This means that Timeout between one character and the other character in receiving mode is automatically set to 40mS.	R/W
Bit 11	If set to ON this bit enables mode “modem” for serial port COM2. This means that Timeout between one character and the other character in receiving mode is automatically set to 40mS.	R/W

SM1	2001	Diagnostic Bit (faults/anomalies)		
		Bit 0	This bit is ON in case that the retaining data of the area “special marker” are lost	R/W
		Bit 1	This bit is ON in case that the retaining data of the are “marker” are lost	R/W
		Bit 2	This bit is ON in case that the retaining data of the area EEPROM are lost.	R/W
		Bit 3	This bit is ON in case that calibration data are lost	R/W
		Bit 4	This bit is ON in case of CPU reset or of watchdog intervention	R/W
		Bit 5	This bit is ON in in case of stack overflow on the area reserved to ram.	R/W
		Bit 6	This bit is ON in case of error during calibration proceeding.	R/W
		Bit 7	This bit is ON in case of error/fault of serial Eeprom.	R/W
		Bit 8	This bit is ON in case of error/fault of serial clock.	R/W
		Bit 9	This bit is ON in case of error/fault of analog digital converter 16 bit	R/W
		Bit 10	This bit is ON in case of stack overflow of timed interrupts .	R/W
		Bit 12	ON in case of Analog input AI1 out of range.	R
		Bit 13	ON in case of Analog input AI2 out of range.	R
		Bit 14	ON in case of Analog input AI3 out of range.	R
		Bit 15	ON in case of Analog input AI4 out of range.	R

SM2	2002	Bit for management of bidirectional encoders		
		Bit 0	<p>Loading of counter for bidirectional encoder 1. Setting this bit to “1”, at the end of scanning cycle, the counter of encoder1 (32 bit) is loaded with the value which is set on special marker n°24 (most significant part) and on special marker n°25 (less significant part). The bit is automatically set to OFF at the end of operation.</p>	R/W
		Bit 1	<p>Loading of counter for bidirectional encoder 2. Setting this bit to “1”, at the end of scanning cycle, the counter of encoder 2 (32 bit) is loaded with the value which is set on special marker n°26 (most significant part) and on special marker n°27 (parte bassa). (less significant part). The bit is automatically set to OFF at the end of operation</p>	
		Bit 2	<p>Load counter of bidirectional encoder 1 with zero impulse. Setting this bit to “1”, at the next zero impulse of encoder 1 (connected to input I7), the counter of encoder1 (32 bit) is loaded with the value which has been entered on special marker n°24 (high area) and on special marker n°25 (low area). Bit is automatically set to OFF at the end of operation (available starting with boot 7).</p>	R/W
SM3	2003	Cycle time		
		<i>This word gives the time of last scanning cycle of the program (resolution 100 uS).</i>		R
SM4	2005	Minimum cycle time		
		<i>This word gives the minimum time of scanning cycle for noticed program (resolution 100 uS).</i>		R
SM5	2005	Max. cycle time		
		<i>This word gives the max. time of scanning cycle for noticed program (resolution 100 uS).</i>		R
SM6	2006	Interval of timed Interrupt no. 1		
SM7	2007	Interval of timed Interrupt no. 2		
		<i>These words define the interval for timed interrupts. Value of interval may be set between 1 and 100 ms (example: SM6=1 → 1 ms SM6=100 → 100 ms). For SM6 and SM7 values not included between 1 and 100, the default setting of relevant interrupt is 100 ms. At starting the values are fixed as 100 → 100 ms.</i>		R/W
SM8	2008	Status digital inputs I1÷I16 for test cycle		
SM9	2009	Status digital inputs I17÷I32 for test cycle		

		<i>These words give the status of digital inputs during test (SM0.5=1). Each bit of these words refers to the status of one digital input, starting with less significant bit (SM8.0→I1, SM8.15→I16, SM9.0→I17, SM9.3→I20). These words are automatically set to zero at the starting of PL250A.</i>	R/W
SM10	2010	Min. value analog output AQ1	
SM11	2011	Min. value analog output AQ2	
		<i>The value of analog output AQ (SM14 or SM15) for which the volt output must be 0,0V. These words are directly modified using the instruction RANGE(AQx,Min,Max). Automatically set to zero at starting.</i>	R/W
SM12	2012	Max value analog output AQ1	
SM13	2013	Max value analog output AQ2	
		<i>The value of analog output AQ (SM14 or SM15) for which the volt output must be 10,0V. These words are directly modified using the instruction RANGE(AQx,Min,Max). Automatically set to 100 at starting.</i>	R/W
SM14	2014	Value of analog output AQ1	
SM15	2015	Value of analog output AQ2	
		<i>Values of these words define the values of continuous outputs AQ1 and AQ2. The tension value of both outputs is given by the formules below: $AQ1(\text{volt}) = ((SM12-SM14)/(SM12-SM10))*10,0$ $AQ2(\text{volt}) = ((SM13-SM15)/(SM13-SM11))*10,0$ Setting the output value equals to minimum limit, output will be 0,0 volt; setting the value equals to max. limit, the output will be 10,0 volt. If output value is not included in the interval Minimum<Value<Maximum, the value for rating volt output is automatically reset within the minimum and maximum limit. Automatically set to zero at starting</i>	R/W

SM20	2020	Countings of counter bidirectional encoder 1 (high area)	
SM21	2021	Countings of counter bidirectional encoder 1 (low area)	
SM22	2022	Countings of counter bidirectional encoder 2 (high area)	
SM23	2023	Countings of counter bidirectional encoder 2 (low area)	
		<i>These words contain the value of bidirectional counters for encoders 1 and 2. Counting is stored even in case of power failure and it is automatically updated at each program scanning.</i>	R
SM24	2024	Loading value for counter of encoder 1 (high area)	
SM25	2025	Loading value for counter of encoder 1 (low area)	
		<i>These words contain the value (expressed as countings) which is loaded on counter of encoder 1 when loading bit SM2.0 is set to "1".</i>	R/W
SM26	2026	Loading value for counter of encoder 2 (high area)	
SM27	2027	Loading value for counter of encoder 2 (low area)	
		<i>Countings value loaded on counter of encoder 2 when loading bit SM2.1 is set to "1".</i>	R/W
SM28	2028	Countings per second of encoder 1	
SM29	2029	Countings per second of encoder 2	
		<i>Number of countings completed by the encoders during last second. These words are automatically updated every second</i>	R
SM30	2030	Countings per tenth of second for encoder 1	
SM31	2031	Countings per tenth of second for encoder 2	
		<i>Number of countings read by encoders during last 100 ms. These words are automatically updated every 100 ms..</i>	R
SM32	2032	Configuration COM1 in mode free-port	
SM33	2033	Configuration EXP1 in mode free-port	
SM34	2034	Configuration COM2 in mode free-port	
		<i>These words enable the mode FREE-PORT on serial ports, setting also the relevant parameters. Enabling this mode, the protocol of serial communication is disabled with consequent direct access to transmission and receipt of data on port. These parameters are initialized at 0 on starting (mode free-port disabled).</i>	R/W

	Bit 0÷3	Baud rate of serial port in mode free-port according to following values 0 → 4800 baud 6 → 110 baud 1 → 9600 baud 7 → 150 baud 2 → 19200 baud 8 → 300 baud 3 → 28800 baud 9 → 600 baud 4 → 38400 baud 10 → 1200 baud 5 → 57600 baud 11 → 2400 baud	R/W
	Bit 4÷7	Format of data for communication of serial port in mode free-port. 0 → 8,N,1 6 → 8,N,2 1 → 8,O,1 7 → 8,O,2 2 → 8,E,1 8 → 8,E,2 3 → 7,N,1 9 → 7,N,2 4 → 7,O,1 10 → 7,O,2 5 → 7,E,1 11 → 7,E,2	R/W
	Bit 8	Set this bit to “1” to enable mode free-port, or set it to “0” to restore standard mode for serial port, allowing communication according to selected protocol.	R/W
SM35	2035	No. of characters on RX buffer of COM1	
SM36	2036	No. of characters on RX buffer of EXP1	
SM37	2037	No. of characters on RX buffer of COM2	
		<i>These words contain the number of valid character on RX buffer of each serial port. These words are used to check the no. of received characters in mode free-port. Any writing on these words will empty the RX buffer, setting the value at zero.</i>	R/W

SM38	2038	Filter analog inputs (<i>default 5 averages</i>)	
		<i>A filter may be applied to the signals of analog inputs, selecting the number of values to consider in the average for the rating of final input value. Range of admitted filter values: 1 to 5 averages..</i>	R/W
SM39	2039	Filter digital inputs (<i>default 10 ms</i>)	
		<i>A filter may be applied to the signals of digital inputs entering a delay time. If the state of input changes, new state will be confirmed only if input will keep this state for the given time. Data will be confirmed after that filter will have eliminated noises and stabilized the inputs lines. PL250A accepts delay time values between 0 and 50 ms.</i>	R/W
SM40	2040	Configuration Analog input AI1	
SM41	2041	Configuration Analog input AI2	
SM42	2042	Configuration Analog input AI3	
SM43	2043	Configuration Analog input AI4	
		<p><i>These special marker words define the type of sensor connected to analog inputs AI1, AI2, AI3 and AI4 (select properly the jumpers for configuration of inputs). At starting these words are automatically selected as input 0..10V.</i></p> <p>0 → Digital input 1 → Input 0÷10V (resolution 10 bit) 2 → Input 0÷20mA 3 → Input 4÷20mA</p> <p>Configurations only for PL250A-x1AD:</p> <p>4 → Input 0÷1V 5 → Input 0÷20mV 6 → Input thermocouple type K 7 → Input thermocouple type S 8 → Input thermocouple type T 9 → Input thermocouple type R 10 → Input thermocouple type J 11 → Input thermocouple type E 12 → Not available 13 → Input RTD type PT100 14 → Input RTD type NI100</p>	R/W

SM44	2044	Min. value for Analog input AI1 linear	
SM45	2045	Min. value for Analog input AI2 linear	
SM46	2046	Min. value for Analog input AI3 linear	
SM47	2047	Min. value for Analog input AI4 linear	
SM48	2048	Min. value for Analog input AI1 linear	
SM49	2049	Min. value for Analog input AI2 linear	
SM50	2050	Min. value for Analog input AI3 linear	
SM51	2051	Min. value for Analog input AI4 linear	
		<i>Set the minimum and maximum numeric limits for analog conversion of inputs AI configured as V/I (current and tension) . These words are modified using the instruction RANGE(AIx,Min,Max). Default settings at starting is 0 for minimum value and 1000 for maximum value.</i>	R/W
SM52	2052	Offset calibration Analog input AI1	
SM53	2053	Offset calibration Analog input AI2	
SM54	2054	Offset calibration Analog input AI3	
SM55	2055	Offset calibration Analog input AI4	
SM56	2056	Gain calibration Analog input AI1	
SM57	2057	Gain calibration Analog input AI2	
SM58	2058	Gain calibration Analog input AI3	
SM59	2059	Gain calibration Analog input AI4	
		<i>These words define the calibration of conversion for AI1, AI2, AI3 , AI4. They are used to correct eventual mistakes of reading. The formule is as follows: Value AIx = Value AIx + (Value AIx * Gain calibration AIx) / 1000 Offset calibration AIx. At starting all calibration values are set to zero.</i>	R/W
SM60	2060	Value Analog input AI1	
SM61	2061	Value Analog input AI2	
SM62	2062	Value Analog input AI3	
SM63	2063	Value Analog input AI4	
		<i>Numeric values of analog inputs AI obtained rating between minimum, maximum values, the conversion and the values of offset and gain.</i>	R

SM65	2065	Min. value trimmer TR1	
SM66	2066	Min. value trimmer TR2	
SM67	2067	Min. value trimmer TR1	
SM68	2068	Min. value trimmer TR2	
		<i>Min. and max. numeric limits of analog conversion for trimmer TR. These words are modified with the instruction RANGE(TRx,Min,Max). At starting the min. value is set to 0 and max. value is set to 1000.</i>	R/W
SM69	2069	Value trimmer TR1	
SM70	2070	Value trimmer TR2	
		<i>Numeric value of trimmer TR obtained by calculation between minimum, maximum value and conversion</i>	R
SM75	2075	Seconds internal clock (0..59)	
SM76	2076	Minutes internal clock (0..59)	
SM77	2077	Hour internal clock (0..23)	
SM78	2078	Date internal clock (1..31)	
SM79	2079	Month internal clock (1..12)	
SM80	2080	Year internal clock (0..99)	
SM81	2081	Week day internal clock (0→Sunday ... 6→Saturday)	
		<i>These words contain date and time generated by internal clock. Writing on each of these words, the internal clock will be automatically updated .Internal battery allows regular clock working also in case of power failure.</i>	R/W
SM82	2082	Offset of protocol address of PL250A	
		<i>This value is added to the value obtained from the combination of jumpers used to select the address (see paragraph 1.6.12 Protocol address PL250A). Default setting at starting is 1.</i>	R/W
SM83	2083	Status of selection jumpers	
		<i>This word gives the position of jumpers used for selection of protocol address. If jumper is closet, the relevant bit is automatically set to "1", if jumper is open the bit is set to zero.</i>	R
		Bit 0	Status of jumper JP14
		Bit 1	Status of jumper JP13
		Bit 2	Status of jumper JP15.
SM84	2084	Status serial COM1	
SM85	2085	Status serial EXP1	
SM86	2086	Status serial COM2	

		<i>These words contain the status of communication serials COM1, EXP1, COM2. Each bit of each word notices the condition of failed communication (off line) or error for data sent or received by means of instructions COM_1÷16 or EXP_1÷16 (example: SM84.0=1 means error in the instruction COM_1(...)). If serial is configured with slave protocol, fault condition is noticed setting to “1” all bit of relevant word.</i>	R
SM87	2087	Baudrate serial COM1 (default 9600 baud)	
SM91	2091	Baudrate serial EXP1 (default 9600 baud)	
SM95	2095	Baudrate serial COM2 (default 19200 baud)	
		<i>The value entered for this word defines the baudrate of serial port ¹.</i>	R/W
		0 → 4800 baud	
		1 → 9600 baud	
		2 → 19200 baud	
		3 → 28800 baud	
		4 → 38400 baud	
		5 → 57600 baud	

¹ In order that changes are confirmed and activated, this word must be set during initialisation. In case that any change is made or it is made in other parts of the program, the baudrate will remain the default value of starting.

SM88	2088	Format of serial COM1	
SM92	2092	Format of serial EXP1	
SM96	2096	Format of serial COM2 ¹	
		<i>Select format of communication data for serial port</i> ² . 0 → 8,N,1 (default at starting) 6 → 8,N,2 1 → 8,O,1 7 → 8,O,2 2 → 8,E,1 8 → 8,E,2 3 → 7,N,1 9 → 7,N,2 4 → 7,O,1 10 → 7,O,2 5 → 7,E,1 11 → 7,E,2	R/W
SM89	2089	Answer delay/Waiting data on receipt COM1 (default 20 ms)	
SM93	2093	Answer delay/Waiting data on receipt EXP1 (default 100 ms)	
SM97	2097	Answer delay/Waiting data on receipt COM2 (default 0 ms)	
		<i>The value of this word defines:</i> <ul style="list-style-type: none"> • Slave protocol: minimum delay between end of serial receipt from a master device and the start of answer broadcast from PL250A (max 100ms). • Master protocol: max. waiting between start of polling broadcast from PL250A and complete receipt of answer from slave device. <i>Value is expressed as ms.</i>	R/W
SM90	2090	Number of errors for signal about status COM1 (default 10)	
SM94	2094	Number of errors for signal about status EXP1 (default 10)	
SM98	2098	Number of errors for signal about status COM2 (default 10)	
		<i>Value entered for this word defines the number of consecutive communication errors after which the anomaly is notified in the relevant bit of “serial status”.</i>	R/W

¹ Format cannot be modified (8,N,1).

² To activate the new settings, this word must be modified in the initialization function. In case that no change has been made or any change has been made in other parts of the program, format will remain the same as default at starting.

1.7.3 Memory area “digital inputs I”

This memory area “digital inputs I” is the area in which the state of digital inputs is stored. It is organized in words; each of the 16 bit of the word represents the state of an input. For instance: the state of digital input I20 is stored on bit no. 3 of word 2 in area I. The area consists of 4 words. The first and the second are updated with actual state of inputs at the starting of each cycle, while the last two words may contain the state of inputs read via serial communication from an expanded module.

1.7.4 Memory area “digital outputs Q”

This memory area stores the state of digital outputs. It is organized in words; each of the 16 bit of the word represents the state of an output. . For instance: the state of digital output Q1 is stored on bit no. 0 of word 1 in the area Q. The area consists of 8 words. The first one is transferred to the outputs of PL250A at the end of each cycle, the other ones may contain the state of further outputs to write them via serial communication on an expanded module.

1.7.5 Memory area “support marker M”

The memory area M contains the status of all markers (bit contacts) used in the program. It is organized in word; each of 16 bit of the word means the status of a marker. Example: status of marker M1 is stored on bit number 0 of word 1 in the area M. The area is composed of 8 words.

1.7.6 Area memoria “analog inputs AI”

In this memory area “analog inputs AI” the PL250A stores the value which is assumed by analog inputs. The value is rated according to min. and max. limits which have been set as range of analog input.

1.7.7 Memory area “inputs trimmer TR”

In this area the PL250A stores the value assumed by trimmers. The value is rated according to min. and max. limits which have been set as range of trimmer.

1.7.8 Memory area “analog outputs AQ”

Memory area “analog outputs AQ” is the memory which assigns values for analog outputs. Percentage of analog output will be calculated starting from the entered value considering min and max range of analog output.

1.7.9 Memory area ”timer T”

Timers are stored in this area. If timer is enabled, the value contained in this area will increase or decrease according to type of time, with the resolution chosen at the starting of timer.

1.7.10 Memory area “preset timer PT”

Memory area “preset timer PT” is the memory where the preset values of timers are stored.

1.7.11 Memory area “counters C”

This memory area contains values of counters. According to type of counter, at each counting operation, the value contained in this area will be updated.

1.7.12 Memory area preset values of counters PV

In this area the preset values of counters PV are stored.

1.7.13 Memory area EEPROM

EEPROM area is the self-retaining memory to store all data which cannot be lost even if PLC is switched-off for long periods (over 6 months). Data stored in this area are tested at the starting of PLC to check their integrity and in case of anomaly, the fault condition is notified (SM1.2) and the whole area is initialized at 0 (zero). Access and writing in this area requires longer time than any other area, therefore it is recommended not to use this area for frequent access, but only at starting to copy the stored data, for example in area V, and then to use these for quick access, guaranteeing a faster program.

1.7.14 Memory area MMC

MMC area is the optional external memory which can be used to save big amounts of data which must be stored even by lack of power supply. Memory is Eeprom, therefore access to this area is slower than access to area V and SM. PL250 does not check integrity of data saved in this area.

This area is divided in words (0+32767) and can be entered also by Modbus protocol.

1.7.15 Memory area COMx_SEND and EXP1_SEND

Memory area COMx_SEND and EXP1_SEND are used to load data which will be sent to the relevant serial port. They are used only in mode free-port. In standard mode these areas are handled with the selected communication protocol.

These areas are divided in byte (8 bit).

1.7.16 Memory area COMx_RECEIVE and EXP1_RECEIVE

Memory areas COMx_RECEIVE and EXP1_RECEIVE are used to save data received by the relevant serial port. They are used only in mode free-port. In standard mode these areas are handled with the selected communication protocol.

These areas are divided in byte (8 bit).

1.8 Protocol Modbus RTU slave

Module PL250A is conceived for the use with SCADA systems or Operator panels via Modbus protocol RTU. Serial communication enables reading and modifying of data on available memory areas, entering and visualizing any data concerning the PLC. Module PL250A is provided with 2 serial communication ports which are enabled to operate as **slaves** with MODBUS protocol:

- COM1 - RS485 available on connector plug-8 and on pins¹ (43,44 e 45).
- COM2 - RS232 available on connector plug-8 (COM1).

Both serials support protocol modbus RTU as described below. Therefore the module PL250 may be connected and may communicate with 2 master devices at the same time.

Main features of protocol Modbus RTU	
Baud-rate	9600 bits/sec (default)
Format	8,N,1 (8 bit, no parity, 1 stop) (default)
Supported function	BITS READING (0x01, 0x02) WORDS READING (max 30 word) (0x03, 0x04) SINGLE BIT WRITING (0x05) SINGLE WORD WRITING (0x06) MULTIPLE BITS WRITING (0x0F) MULTIPLE WORDS WRITING (max 30 word) (0x10)
Error codes	ILLEGAL FUNCTION CODE (0x01) ILLEGAL DATA ADDRESS (0x02) ILLEGAL DATA VALUE (0x04)
Broadcast	Simultaneous writing to all connected slaves using address 0x00 and no answer by slaves.
Polling with unknown address	with slave Polling using address 0xFF, any connected slave can answer

¹ If COM1 is enabled on pins, digital inputs I18, I19, I20 will not be available.

1.9 Addresses word/bit of PL250A for protocol Modbus RTU

The following tables give all data (word and bit) which may be entered via Modbus protocol. For all data the table gives reading/writing elements and the value assumed at starting of PL250. According to initialization value at starting, the following options are given:

1. **“ROM”** fixed value defined by program.
2. **“EEP”** value stored on Eeprom for 10years even in absence of power supply
3. **“TAMP”** value stored on Ram memory with buffer battery. These data are stored in absence of power supply for a limited time (approx. 4 months)
4. **“?”** value of these data is unknown at starting
5. Defined value. The value assumed at starting is the value defined in the table.

WORD			
MODBUS ADDRESS	DESCRIPTION	READ/ WRITE	RESET VALUE
0	Device type	R	ROM
1	Software release PL250A	R	ROM
2	Protocol activated on COM1	R	ROM
3	Protocol activated on EXP1	R	ROM
4	Protocol activated on COM2	R	ROM
5	Protocol address	R	TAMP
1000 ÷ 1199	Word area variables V	R/W	TAMP
2000 ÷ 2099	Word area special marker SM	R/W	TAMP
3000 ÷ 3095	Word area timer T	R/W	0
4000 ÷ 4095	Word area preset timer PT	R/W	0
5000 ÷ 5031	Word area counters C	R/W	0
6000 ÷ 6031	Word area preset counters PV	R/W	0
7000 ÷ 7126	Word area EEPROM	R/W	EEP
10000 ÷ 10031	Word % prop/integr/deriv/outputs PID	R	0 TAMP TAMP TAMP 0 ... TAMP
10000	% proportional action PID1		
10001	% integral action PID1		
10002	% derivative action PID1		
10003	% output PID1		
10004	% proportional action PID2		
...	...		
10031	% output PID8		
32768÷65535	Word area MMC	R/W	EEP

WORD			
MODBUS ADDRESS	DESCRIPTION	READ/ WRITE	RESET VALUE
100	N.O. contacts digital inputs I1÷I16	R	?
101	N.O. contacts digital inputs I17÷I32	R	?
102	N.O. contacts digital inputs I33÷I48	R	0
103	N.O. contacts digital inputs I49÷I64	R	0
110	N.O. contacts digital outputs Q1÷Q16	R	0
111	N.O. contacts digital outputs Q17÷Q32	R	0
112	N.O. contacts digital outputs Q33÷Q48	R	0
113	N.O. contacts digital outputs Q49÷Q64	R	0
114	N.O. contacts digital outputs Q65÷Q80	R	0
115	N.O. contacts digital outputs Q81÷Q96	R	0
116	N.O. contacts digital outputs Q97÷Q112	R	0
117	N.O. contacts digital outputs Q113÷Q128	R	0
120	N.O. contacts bistable relays B1÷B16	R/W	0
121	N.O. contacts bistable relays B17÷B32	R/W	0
122	N.O. contacts bistable relays B33÷B48	R/W	0
123	N.O. contacts bistable relays B49÷B64	R/W	0
130	N.O. contacts timer T1÷T16	R	0
131	N.O. contacts timer T17÷T32	R	0
132	N.O. contacts timer T33÷T48	R	0
133	N.O. contacts timer T49÷T64	R	0
134	N.O. contacts timer T65÷T80	R	0
135	N.O. contacts timer T81÷T96	R	0
140	N.O. contacts counters C1÷C16	R	0
141	N.O. contacts counters C17÷C32	R	0
150	N.O. contacts positioners on/off POS1÷POS2	R	0
160	N.O. contacts tuning positioners on/off POS1÷POS2	R	0
170	N.O. contacts support markers M1÷M16	R	0
171	N.O. contacts support markers M17÷M32	R	0
172	N.O. contacts support markers M33÷M48	R	0
173	N.O. contacts support markers M49÷M64	R	0
174	N.O. contacts support markers M65÷M80	R	0
175	N.O. contacts support markers M81÷M96	R	0
176	N.O. contacts support markers M97÷M112	R	0
177	N.O. contacts support markers M113÷M128	R	0

BIT			
MODBUS ADDRESS	DESCRIPTION	READ/ WRITE	RESET VALUE
1600 ÷ 1663	N.O. contact digital input I1 ÷ N.O. contact digital input I64	R/W	?
1760 ÷ 1887	N.O. contact digital output Q1 ÷ N.O. contact digital output Q128	R/W	0
1920 ÷ 1983	N.O. contact bistable relay B1 ÷ N.O. contact bistable relay B64	R/W	0
2080 ÷ 2175	N.O. contact timer T1 ÷ N.O. contact timer T96	R	0
2240 ÷ 2271	N.O. contact counter C1 ÷ N.O. contact counter C32	R	0
2400 ÷ 2401	N.O. contact positioning on/off POS1 ÷ N.O. contact positioning on/off POS2	R	0
2560 ÷ 2561	N.O. contact tuning Positioning on/off POS1 ÷ N.O. contact tuning Positioning on/off POS2	R	0
2720 ÷ 2847	N.O. contact support marker M1 ÷ N.O. contact support marker M128	R/W	0
16000 ÷ 19199	Bit 0 area marker V0 ÷ Bit 15 area marker V199	R/W	TAMP
32000 ÷ 33599	Bit 0 area special marker SM0 ÷ Bit 15 area special marker SM99	R/W	TAMP

2 Ladder programming PL250A

2.1 General features

The software tool PLProg for Windows allows to program module PL250A. The ladder programming enables to draw the logic diagram of the application and to store it on PLC.

2.2 Elements of Ladder programming

Available elements with relevant features are listed below.

2.2.1 Contacts digital inputs I

Contacts I contains the state of digital inputs of PL250A and eventually of one more expansion. The N.O. contact is closed (on) when bit value is 1 (active input). The N.C. contact is open (on) when bit value is 0 (input not active).

2.2.2 Relay outputs/SSR/auxiliary Q

PL250A is provided with 128 outputs type “Q”, each composed of one coil and the relevant logic contact N.O. and N.C. which may be used to draw the ladder diagram. On hardware of PL250A only 12 relay outputs/SSR Q are physically available, the other ones are available as auxiliary relays.

Energizing coil “Q”, the relevant logic contact will close (N.O.) or open (N.C.). The contacts of physical outputs are all N.O. and at starting all contacts N.O. are open.

2.2.3 Bistable relays B

64 bistable relays are available. Each consists of one coil and the relevant logic contact N.O. and N.C. .

Energizing coil “B”, the relevant logic contact will change its state (it opens if previously closed, it closes if previously open). The N.O. contact is closed (on) when bit value is 1. The N.C. contact is open (on) when bit value is 0. At starting of PLC the N.O. contact is open.

2.2.4 Timer T

Three different operating modes are available for Timers:

- **TON.** Mode **Start timing as delay at insertion** counts time when coil is active (ON). Timing bit (contact T) is activated when actual value (T) is bigger or equals to preset time (PT). When coil is deactivated (OFF), actual value of timer “delay at insertion” is reset. Timer keeps on counting after reaching preset value and it stops reaching the max. value 32767.
- **TOFF.** Mode **Start timing as delay at disconnection** allows to delay the deactivation of an output for a certain time after that the input has been deactivated. When coil is activated, the timing bit (contact T) is immediately activated and the actual value (T) is set to zero. At deactivation of coil, the timer counts until elapsed time is equals to preset timer (PT). After reaching the preset timer, timing bit is deactivated and actual value does not increase. If input is deactivated for a time which is lower than preset time, the timing bit is still active. To start counting, the function TOF must notice a transition from activated to deactivated (ON → OFF).
- **TONR.** Mode **Start timing as delay at insertion with memory** counts time when coil is activated (ON). Timing bit (contact T) is activated when actual value (T) is bigger or equals to preset time (PT). When coil is deactivated (OFF), actual value of timer “delay at insertion with memory” is stored. This value allows to accumulate time for more activation periods of the coil. Actual value of timer can be reset with operation MOV(Tx = #0). Timer keeps on counting after reaching preset value and it stops reaching the max. value 32767.

Timers with operating modes TON, TONR and TOF are available in three different resolutions, not depending from number of timer; they can be activated with time basis 10 ms, 100ms and 1s. Each counting of actual value is multiple of time base. Example counting of 50 in a timer with time base 10 ms is equals to 500 ms. Preset time (PT) can be directly loaded with a value or by means of a variable in the area VW, SMW, AI, TR.

2.2.5 Counters C

Counters are available with two operating modes:

- **MUP.** In mode **Count Up** the counting bit (contact C) is activated when present value (C) is \geq to preset value (PV). Counter counts up every time that the counting-up input Cx(UP) goes from Off to On and it counts down every time that the counting-down inputs Cx(DOWN) goes from Off to On.

The counter is reset when the reset input Cx(RESET) is activated or when the operation MOV(Cx = #0) is executed. At reaching of max. value (32.767), the next edge-up of the counting-up input will keep unchanged the actual value. Similarly at reaching of minimum value (-32.768) the next edge-up of the counting-down input will keep unchanged the actual value. The up-counters have an actual value which keeps the actual counting (T). They also have a preset value (PV) which is compared to the actual value at the end of each program cycle. If actual value is bigger or equal to preset value, the counting bit is activated (contact C), otherwise it is deactivated. Please use number of counter to refer both to actual value and to Contact C of the counter itself.

- **MDOWN.** In mode **Count Down**, the counting bit (contact C) is activated when present value is equals to zero. The counter counts down starting from a preset value (PV) on the edge-up of the counting-down input Cx(DOWN) and it counts up on the edge-up of the counting-up input Cx(UP). At reaching of max. value (32.767), the next edge-up of the counting-up input will keep unchanged the present value. The counter resets the counting bit (contact C) and load present value with preset value (PV) when loading input Cx(RESET) is activated. The counter in mode count-down stops counting when it reaches zero. Please use number of counter to refer both to actual value and to Contact C of the counter itself

Preset value (PV) may be directly loaded with a value or it may be loaded by one the variables in the area VW, SMW, AI, TR.

2.2.6 Function Math formules FM

The function FM allows to perform math operations (+, -, *, /, |, &, ^, <<, >>) between two operators and to save the result in another memory location. The operators can be numeric or they may also refers to available memory areas.

2.2.7 Assignement Function MOV

The function MOV allows to assign to the specified memory location a numeric value or a value assumed by another memory location.

2.2.8 Assignement Function BLKMOV

The function BLKMOV allows to assign to the memory block a numeric value or the value assumed by another block of memory locations .

2.2.9 Indexed Assignment Function MOVIND

The indexed assignment function MOVIND allows to assign to a certain memory location specified by another memory location a numeric value or the value assumed by another memory location selected in the area specified by a memory location which is the index. This type of assignment allows to consider the memory areas as vectors of a certain number of locations: by means of the value assumed by another location called “index” it is possible to enter the value of the area $n=0, n=1, \dots, n=N-1$

2.2.10 Assignment function MOVTEXT

Starting with the specified memory location, the assignment function MOVTEXT allows to save the characters of a string sent as parameter to the function. Following types of format are available for characters of string in the memory area:

- **ONE_CHARACTER_PER_WORD** : in this format each word of destination area will contain only one character of string
- **TWO_CHARACTERS_PER_WORD** in this format each word of destination area will contain two characters of string, starting with high area of the word
- **ONE_CHARACTER_7_SEGMENTS_PER_WORD**

2.2.11 Contacts II immediate digital inputs

Contacts II allow to read immediately the state of consentono digital input. The N.O. contact is closed (On) when bit value is 1 (active input). The N.C. contact is open (On) when bit value is 0 (deactivated input).

2.2.12 Immediate outputs QI

By means of direct access to outputs QI, PL250A allows to directly work on outputs Q during the ladder program execution, even without waiting the end of program. The command is allowed only on hardware outputs of PL250A (QI1..QI12).

2.2.13 Contact IF

The operation “conditional comparison IF” allows to compare the values of 2 variables in any memory area. Following comparisons are allowed:

=, >=, <=, >, <, <>. Contact is active when comparison is true.

2.2.14 Functions SBIT and RBIT

Function SBIT sets to “1” a bit of a memory area when the coil of function is activated.

Function RBIT sets to “0” a bit of a memory area when the coil of function is activated.

Number of bit is 0 to 15, bit 0 is the less significant bit (LSB).

2.2.15 Contact BIT

This operation rates the value of a bit in a memory area. N.O contact is closed (On) when bit value is 1. N.C. contact is open (On) when bit value is 0. Number of bit is 0 to 15, bit 0 is the less significant bit (LSB).

2.2.16 Function RANGE

The RANGE function defines minimum and maximum limits for analog inputs AI, for trimmer TR, for analog outputs AQ and for PID outputs.

Concerning analog inputs AI and trimmer TR, the minimum and maximum values allow to translate the counting value of the analog-digital conversion into a value which can be used inside the program. Below an example:

RANGE(AI1, Min 10, Max 200)

For analog input AI1 the function defines the minimum limit as 10 and the maximum limit as 200. In case that analog input AI1 would be connected to a potentiometer to fix a preset time (PT) of a timer with time-base 100ms, the result would be a variable time between 1.0 and 20.0 seconds, according to the position of potentiometer.

Concerning analog outputs AQ, minimum and maximum value allow to rate the effective tension value of output 0÷10V. Below an example:

RANGE(AQ1, Min -200, Max 500)

For analog output AQ1 the minimum limit is fixed as -200 and the maximum limit is fixed as 500. This means that setting numeric value of output as -200, the output AQ1 will be 0 Volt while setting the numeric value as 500 the output AQ1 will be 10Volt. In case that entered value are not included in the interval specified by function RANGE, the output is kept within minimum and maximum values. For intermediate values, output tension is rated according to following formula:

$$Output(volt) = ((Value - Min) * 10) / (Max - Min)$$

Maximum resolution for output AQ1 and AQ2 is 8 bit.

Concerning PID outputs, minimum and maximum values allow to rate the value for the output of PID control algorithm. Below an example:

RANGE(PID1, Min 100, Max 500)

For PID1 output , minimum limit is fixed as 0 and maximum limit is 500. This means that for output 0% the PID output will be equals to minimum fixed value and for output 100% the PID output will be equals to maximum fixed value. For each PID [1..8], minimum and maximum values of output are initialized at starting as 0 and 10000.

2.2.17 Contact NOT

Contact NOT modifies the state of current flow. Current flow stops if it reaches contact NOT and it works if it does not reach contact NOT. The operation NOT modifies logic value from 0 to 1 or from 1 to 0.

2.2.18 Contact P and N

The contact “positive transition P” activates the current flow for a scanning cycle at each transition Off / On. The contact “negative transition N” activates the current flow for a scanning cycle at each transition On / Off. When the operation “positive transition P” detects a transition of logic value from 0 to 1, it sets this value to 1, otherwise to 0. When the operation “negative transition N” detects a transition of logic value from 1 to 0, it sets this value to 1 , otherwise to 0.

2.2.19 Function SEND and mode Free-port

Function SEND allows to activate data transmission by means of serial ports in mode free-port. In this mode, which can be activated by special marker SM32, SM33 and SM34, the protocol which usually handles the serial ports is disabled and the ports as well as the relevant TXT and RX buffers are controlled by the ladder program. After loading on buffer the data to send and activating function SEND (which uses serial port and no. of characters to send as parameters) these data will be sent on serial line. During the transmission of data, bit SM0.7, SM0.7 or SM0.8 (according to transmission port) will be set to “1”, while it will be set to “0” at the end of transmission. It is possible to check the answer of a connected device by means of SM35, SM36 and SM37, which contain the number of characters received and saved on RX buffer of each serial port. Any writing on each of these special marker will empty the RX buffer. Calls to function SEND before the end of previous transmission or with mode free-port disabled will be ignored by the program.

2.2.20 Function TunePOS and POS (positioning axis ON/OFF)

Function “TunePOS” completes the autotuning which is necessary to rate reaction time and inactivity time of the axis on which a positioning procedure is required. The function “POS” proceeds to the ON/OFF positioning of an axis. Both functions operate on the same memory area with double word access (area marker VD); the start address of the used memory area is required as parameter by functions “TunePOS” and “POS”. The following table shows how data are organized in the memory area used by the two functions, starting from the address of specified location.

Address area VD	Contents
+0	Encoder countings
+2	Countings setpoint value of positioning
+4	Countings max. absolute discart of positioning
+6	Time required to reach max. speed (tenth of seconds)
+8	Status of positioning output (0=stop, 1=onwards, -1=backwards)
+10	Countings of inertia onwards
+12	Countings of inertia backwards
+14	Duration minimum impulse (resolution 0.2 mS)
+16	Countings of displacement after impulse of 100 mS
+18	Countings of displacement after impulse of 500 mS
+20	Countings of displacement after impulse of 1000 mS

To use these functions, proceed as follows:

- Use ladder instruction “MOV” to transfer the counting of used encoder (SMD20 = Encoder 1, SMD22 = Encoder 2) in the field “Encoder countings”.
- Enter the countings value for axis positioning in the field “ Countings setpoint value of positioning ”
- Enter the countings value of max. discart allowed to positioning in the field “ Countings max. absolute discart of positioning ”
- Enter time value (as tenths of second) required for the axis to reach max. speed.
- Start function “TunePOS” and wait until contact “TunePOS no” closes to notify end of Autotuning procedure for axis. Data concerning inertia and reaction time are now automatically stored on the indicated memory area where they remain at disposal for function “POS”.
- Desable function “TunePOS”.

- Start function “POS”. When the axis reaches the setpoint (except for preset discard), contact “POS no” will close to notify end of positioning
- Activate the outputs ONWARDS and BACKWARDS reading value in the field “Output”. If value of “Output” is given by functions “TunePOS” and “POS” as “1”, the output ONWARDS must be activated; if it is “-1” the output BACKWARDS must be activated; if it is “0” no output must be activated.
- Set to zero the value of field “Output” when the functions “TunePOS” or “POS” are disabled, to avoid that output is still set as Onwards or Backwards.

ESEMPIO DI UTILIZZO DELLE FUNZIONI TunePOS e POS

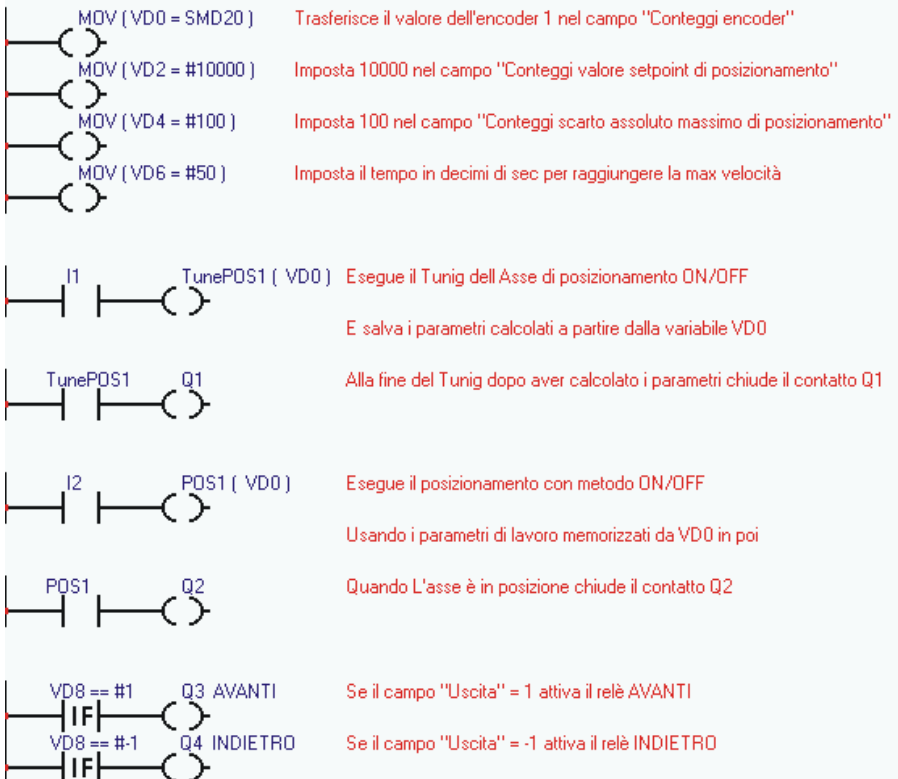

2.2.21 Function “serial communication COM and EXP”

Communication functions COM and EXP enable the programming of the serial ports (COM1-RS485 and EXP1-RS232) for reading/writing of data from connected slave devices using the master protocol selected in the project. These functions are active only when in the project a master communication protocol has been selected for the relevant serial port. A Master protocol means a protocol which enables PL250A to control the serial line communication, controlling the data flow towards slave devices. The two functions are similar, they only refer to a different serial port. Instruction COM operates with interface RS485, allowing to connect more devices on the same line, while instruction EXP operates with interface RS232 allowing to connect one single device to PL250A. Instructions are active until the relevant coil is active. Consider also that, according to communication protocol, the time required for data upgrade can be quite different and read data are not immediately available at activation of coil, but only after a certain time depending from communication delays.

Instructions COM and EXP require the configuration of following parameters:

- Index (max. 16 different serial pollings)
- Type of operation:
- Reading: PL250A will read continuously data from slave device and will store them in an internal memory area
- Writing: PL250A will write continuously data on an internal memory area of the slave device
- Reading/Writing: PL250A will read data on slave device and will store them in an internal memory area; when these internal data on PL250A will be modified by the program, any change will be automatically sent also to slave device by means of a writing instruction (this instruction can work only on a single data each time).
- Slave number (communication address of slave device)
- Data type (word or bit)
- Number of data (or starting number in case of more data)
- Internal memory area of PL250A where data must be read/written
- Word number (the same reading / writing instruction can work simultaneously on more consecutive data)

2.2.22 Functions StartPID , PID , SetOutPID

Functions StartPID, PID and SetOutPID enables control of a process by means of PID algorithm (proportional, integral, derivative).

Function StartPID starts the relevant control block and sets parameters as required. Function can be activated once at the starting or it may be recalled later to modify quickly control parameters. PID integral action is initialized only calling this function and setting integral time to 0, otherwise even in case of switch-off the system will start control action keeping the same percentage of integral action and consequently limiting the transient times. Parameters required by function StartPID are the following:

- Proportional band
- Integral time
- Derivative time
- Dead band

Parameters can be entered with numeric format or referring to internal variables. Integral time is expressed in time unit used for PID function (ex. PID function recalled every 1 sec., integral time expressed in seconds). Derivative time is expressed with one decimal digit more than integral time. Proportional band and dead band are expressed with a numeric value as setpoint and process.

PID function requires following parameters:

- Setpoint
- Process
- Output value
- Type of control action
- Type of output

After acquisition of necessary parameters values, PID function will enter the value obtained by control algorithm in the variable "Output value". This value will have been obtained rescheduling the percentage value 0 – 10000 (0.00% ÷100.00%) between minimum and maximum value of PID output as entered using the function RANGE.

For optimal results, PID function should be recalled at regular intervals. A timer can be used or even an internal Interrupt, to get shorter intervals.

Function SetOutPID is used for control actions which foresee both automatical and manual functions. The function allows to avoid process oscillations when changing from manual to automatical PID control. Following parameters are required:

- Output value

It allows to set the value of PID output, automatically rating the single percentages of proportional and integral action. Changing from manual to automatical operation, PID output will assume the value entered in manual function and it will start control action.

Consequently the function must be used only in manual control, to keep PID output in line with value of manual control.

This function automatically cancels derivative action.

If the function is used with process value outside proportional band, integral action will be set to 0.

2.2.23 Functions StartPOSPID and POSPID

Functions StartPOSPID and POSPID are conceived to assure a simple and quick positioning by reading encoder 1 and by motor control with a tension $\pm 10V$ generated as differential by outputs AQ1 and AQ2. Positioning is achieved with PID algorithm, adding also action "F", which is due to theoretic speed of axis motion.

Function StartPOSPID activates control action, setting the parameters as required. The function can be activated once at starting but it may also be recalled later for a quick change to control parameters. Integral action of PID is initialized only starting this function and setting integral time to 0. Otherwise, even in case of switch-off, the system will start regulation keeping as reference the same percentage of integral action, therefore limiting the time of transient.

Parameters required for function StartPOSPID are the following:

- Proportional band
- Integral time
- Derivative time
- Dead band

Parameters can be entered with numeric format or even referring to internal variables. Integral time is expressed with time unit used to recall function POSPID (example: function POSPID recalled every 1 ms \gg Integral time expressed as milliseconds). Derivative time is expressed with one decimal point more than integral time. Proportional band and dead band are expressed as countings, since they refer to encoder 1.

Parameters required for function POSPID are the following

- Setpoint (countings)
- Value of action F (± 10000)
- Output limits (0...10000)

Function POSPID, after getting setpoint value expressed as countings, value of action "F" and limit of output, will rate value of analogic outputs AQ1 and AQ2, so that value of countings for encoder 1 will be equal to selected setpoint. Value of action "F" will be added to the output value rated by PID (max ± 10000). Keeping value of action "F" to 0 a zero, this action will not affect regulation. The limit of output is conceived to limit the motion speed of axis, particularly setting the limit to 5000 the combined output AQ1 and AQ2 will assume max values $\pm 5.0V$.

To assure optimal operation, the function POSPID must be recalled at regular intervals, therefore it is possible to use an internal interrupt. All data used by these functions are "double word" type(32 bit).

2.2.24 Function GENSET

Function GENSET allows to generate automatically a variable setpoint, with option to enter an acceleration and deceleration ramp. Function GENSET operates on a series of adjoining variables in double word, starting with the location which is given as parameter of the function.

Address area VD	Contents
+0	State of function GENSET 0 → Stop or end motion 1 → Function initialization 2 → Acceleration ramp 3 → Motion at constant speed 4 → Deceleration ramp
+2	Starting Setpoint / Setpoint rated at end of GENSET function (countings)
+4	Final setpoint (countings)
+6	Motion speed (countings * 1000 / time units)
+8	Duration of acceleration ramp (time units)
+10	Duration of deceleration ramp (time units)
+12	Instant speed of setpoint (countings * 1000 / time units)

To use this function, proceed as follows:

- Enter on location VD+2 the starting setpoint
- Enter on location VD+4 the final setpoint
- Enter on location VD+6 max. motion speed as countings*1000/time units (to have 3 decimals. Example: setting 12345 will give a speed of 12.345 countings/time units).
- Enter on location VD+8 the duration of acceleration ramp (expressed as time units; if duration of acceleration ramp must be 1 second and function GENSET is recalled by an interrupt of 1 ms, enter 1000)
- Enter on location VD+10 the duration of deceleration ramp.
- Write "1" on location VD to start the function which will automatically start to write on location VD+2 the generated setpoint. Location VD will also be updated with current state of function, while location VD+12 will be updated with instant speed of setpoint, expressed with 3 decimals. This value may be used to generate action "F" for function POSPID.
- At end of motion, when location VD+2 will reach value of final setpoint, the function will automatically enter standby mode, indicated by value "0" on location VD. This means that function GENSET can be always active, even when motion is not required.

2.2.23 Function CONV

The function CONV provides the conversion of source data in one of the available formats. Conversion type “TO_7SEG_SIGNED” converts input data (one word with sign -32768..32767) in a specified number of digits already suitable for a display with 7 segments. The number of digits to convert, starting from less significant digit, will be sent to the function as parameter.

The codes will be saved (one digit for each word) starting from destination word and then in the following words according to the required number of digits.

Conversion type “TO_7SEG_UNSIGNED” is similar to the above described conversion. The difference is that the source data is considered as unsigned word (0..65535). The code is composed by one bit set to 1 if the segment must be ON and by one bit set to 0 if the segment must be Off. The correspondance between bit and segment is the following:

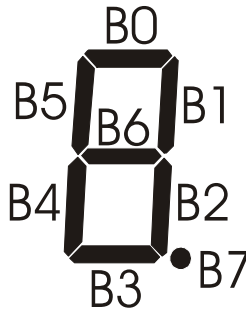

Conversion type “TO_ASCII_SIGNED” converts the entering data (one word with sign -32768..32767) in a specified number of ascii characters. The number of characters to save will be assigned to this function as parameter. Codes of these characters will be saved (one character per word) starting with the destination word and then in the following ones, according to the no. of required characters.

Conversion type “TO_ASCII_UNSIGNED” is similar to the one described above, but the source data is meant as unsigned word (0..65535).