

MULTICHANNEL  
CONTROLLERS, DATA RECORDERS

## DIGiCon

& SCADALite



Measure,  
**Control** and Log Data

2017 - 2018



# Introduction



**DIGiCon = Me ter + Controller  
+ Recorder + HMI + SCADA in one package**

The DigiCon line includes advanced controllers and recorders with great potential closed in small casings. DigiCon has been specifically designed for advanced applications in industrial automatic control engineering. It does not mean, however, that the device cannot be applied in smaller systems. DigiCon can be equipped with three isolated RS-485 interfaces which make it a perfect solution for distributed systems to work as CPU. Thanks to Ethernet interface the device can be monitored via the Internet. A wide range of input and output modules allows to customize DigiCon precisely as the customer requires it. Thanks to a colour touchscreen working with the user interface becomes a pleasure, while DigiCon operation playing the role of HMI is intuitive and comfortable. Our devices are LINUX-based products to ensure stable operation.

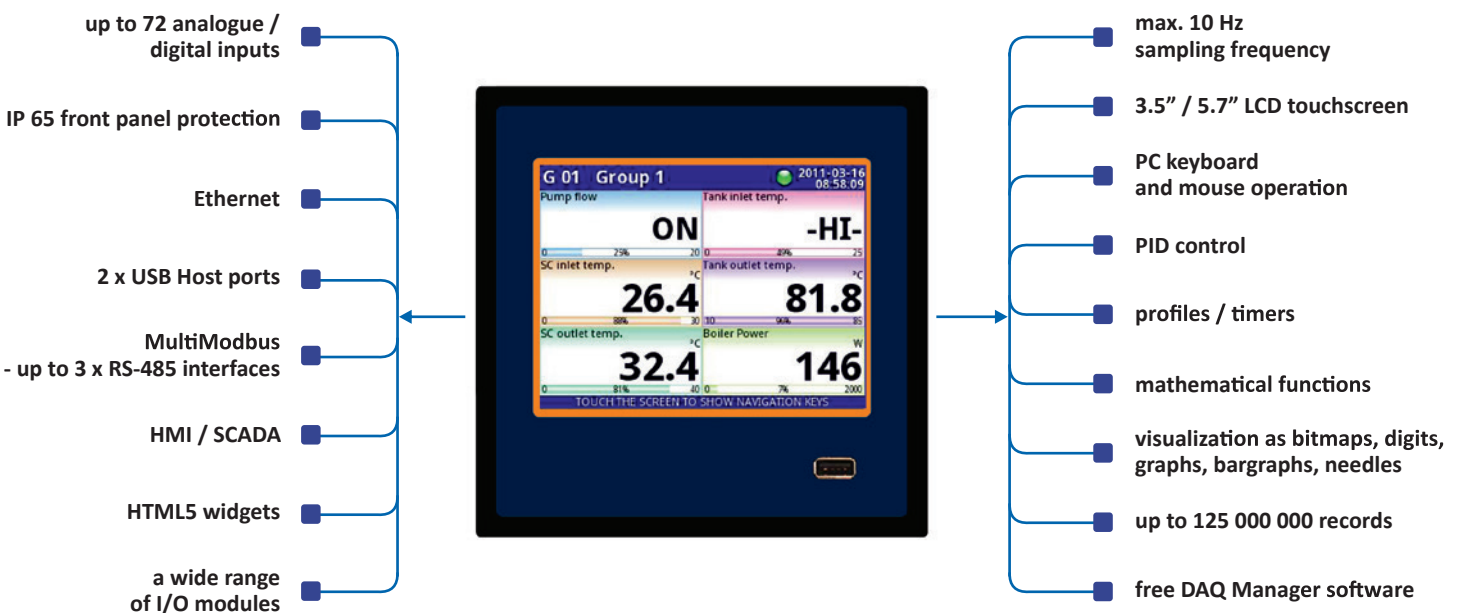

The biggest advantage of all devices from the DigiCon line is a big number of built-in inputs / outputs accessible in one compact device. The most developed version **CMC-99** has up to 48 measurement or digital inputs and 60 virtual channels whereas **CMC-141** has 50% more inputs / outputs and virtual channels.

Thanks to a well-thought-out module design you can choose among a wide range of cards and connect them to slots in the way you wish but you do not have to use all slots. You can also decide on your own how to use virtual channels, if they are going to be used for direct measurement readings, mathematical functions, timers, profile creation, set points or virtual objects.

We offer the following cards:

**inputs:**

- universal
- voltage
- current
- thermocouple
- RTD
- NTC
- digital
- counters
- totalizer
- rate

**outputs:**

- relay
- SSR
- current (4-20 mA) signals

**communication:**

- Ethernet
- RS-485
- RS-232
- USB Host

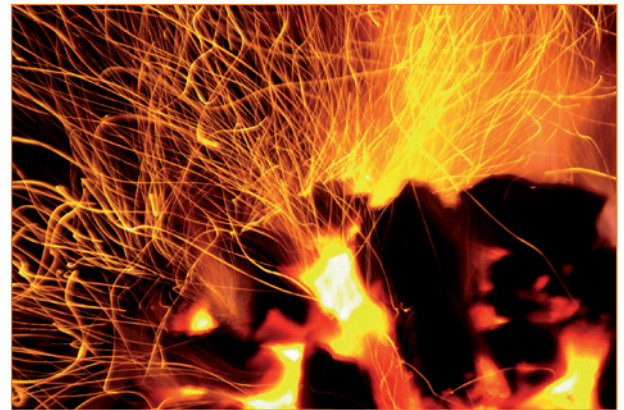

What if one day you want to change your slots configuration or add new cards? All you have to do is to send your device to an authorized distributor who will perform the changes you require.

## Sample configuration

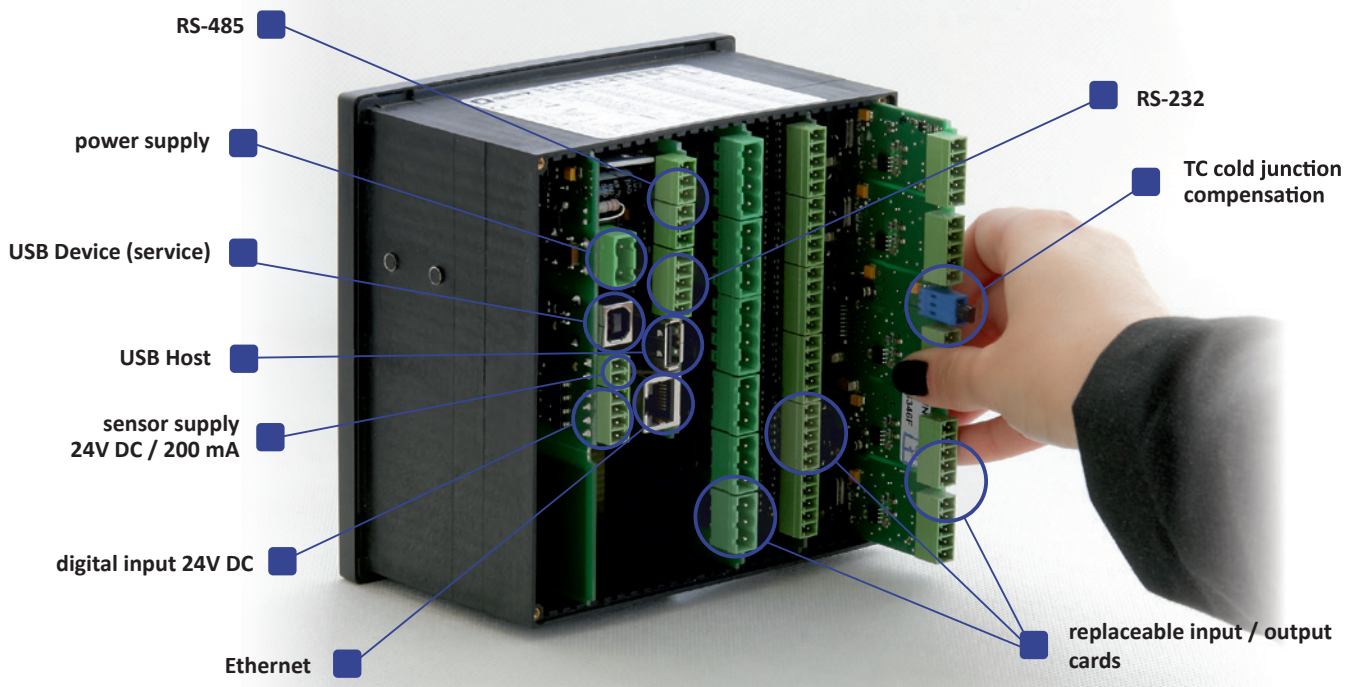



# DIGiCon family

**DIG-99** is the first device in DigiCon line. It's equipped with a 3.5" colour LCD touchscreen which makes user-friendly, easy and comfortable configuration and data presentation readable and attractive. Although the Multicon DIG-99 is build in a quite small housing, it can integrate up to 48 inputs, and its construction allows user almost free configuration by choosing up to 27 available input/output cards. In DIG-99 we have provided 60 logical channels, what is enough to build basic applications.

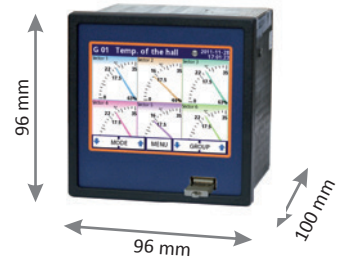

**DIG-141** is CMC-99's bigger brother. It has all features included in DIG-99, but in addition it has a bigger display, more inputs/outputs and even more virtual channels. DIG-141 is equipped with a 5.7" LCD touchscreen. The number of virtual channels was increased to 90, it helps to build sophisticated applications much easier. Despite of small, compact case, unit allows direct connection (in a maximum mount) as many as 72 analogue or digital inputs and thanks to its design the user can configure the device on his own, using a wide range of different I/O cards. Casing depth is still only 100 mm.

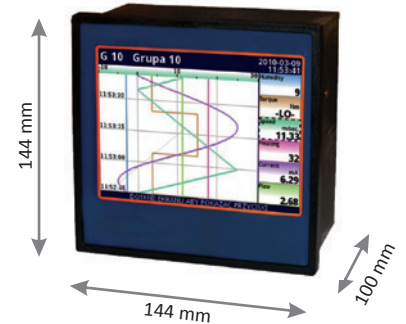

As a result of extending the range of functional applications of the **DigiCon** line, the **CMC-N16** wall mounted model has been designed. The new IP 65 enclosure allows using the device in harsh environments, where safe installation of a typical controller / data recorder in a panel mounted enclosure is impossible. Although the number of available inputs is reduced if compared with the panel mounted model, the functionality available so far has been maintained.

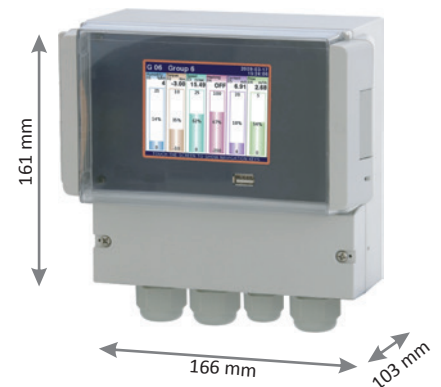

## Controller...



**Signal measurement** is the essential function of the device. This compact appliance, depending on the needs, can be equipped with dedicated modules for the measurement of signals from detectors with a current output (mA), voltage output (in mV and V), from temperature measurement detectors (by thermocouples and RTD elements) or modules with universal inputs that can measure almost any type of signal. Multichannel modules of progressive-reverse counters, tachometers and flow meters and multi-input modules of digital inputs which can read a state of the button and allow for a binary data input has been developed to process digital signals.



**Process control** is a natural consequence of the availability of the aforementioned mechanisms. DigiCon, however, has many more control capabilities hidden within itself than simply standard relay outputs switching. PID control is the basis of modern automation systems and in this device every of 60 (or 90) measurement channels available can be set as an independent PID controller.



**Mathematical functions** allow the measurement results to be operated freely. DigiCon allows you not only to use arithmetic and trigonometric functions such as addition, multiplication, sine, raising to a power, but also logical ones (comparing to a constant, comparing the measured values or multiplexer) which makes the developing of the advanced applications much more easy.



Software built-in **timing profiles** (free programmable runs) allow for the unique freedom in shaping a run control and possibility to start the control process at a preset time or when a defined event occurs. Their functions enable the control to be stopped at a specific time/conditionally at any point of the run, to be looped and it is possible to carry any other operation on a setpoint.

# ...and a recorder in the same package

# DIGiCon

## up to 125 000 000 records!

Data recording makes a kind of a value added to the tremendous possibilities shown above. DigiCon can record any 60 measurement channels at a speed of 10 samples per second. It has 1.5 GB built-in flash memory, enabling for data logging up to 125 000 000 records. The function of data logging has been also optimized for the use of hardware resources of this device - the channels for data logging are grouped (1-6 channels) and in each group a speed of data logging can be freely set. Additionally, there is a unique option of alternative (higher or lower) speed data logging, which is set off only under user-specified conditions. This solution allows you to precisely trace the object parameters in critical situations.

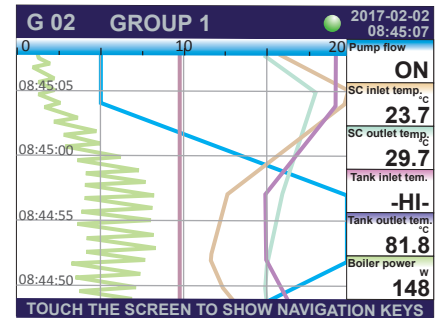

### ■ Data download

The recorded data can be downloaded from the internal memory in a way which suits you best. Use a USB flashdrive or Ethernet which allows you to perform the task wherever you are. Current data can be downloaded via the Internet or a Modbus RTU link.

recording mode	intense (every 1 sec.)	medium (every 10 sec.)	economy (every 1 min.)
60 channels	20 days	6 months	3 years
48 channels	30 days	8 months	4 years
24 channels	50 days	15 months	7 years

# Comfort in your every move

## Colour LCD touchscreen

The time when you had to press buttons to move the cursor within a virtual keyboard to enter one character is long gone. Now you have colour touchscreens to use your device more efficiently and with higher level of comfort. The display reacts accurately even to a slight touch. But if you prefer a traditional keyboard and a USB mouse it's not a problem. Simply connect and use them. On the 3.5" TFT LCD (5.7" in CMC-141), 340 x 240 pixels, 65 536 colours - everything is clear and in pleasant colours.



# SCADALite - a breakthrough in data presentation

**SCADALite** is a functionality allowing for process management directly from the DigiCon screen.

Information important for the operator can be presented in graphical form, including animations, dynamic charts, the most important numbers and, in the case of alarm, also sounds. **SCADALite** enables definition of a specified number of screens to present different range of the required information. The specified measurement parameters can be included in the graphics that reflects the monitored process/facility by means of a photo or drawing.

**SCADALite** is an innovation in data presentation.



✓ Photo



✓ Sketch



✓ CAD Project

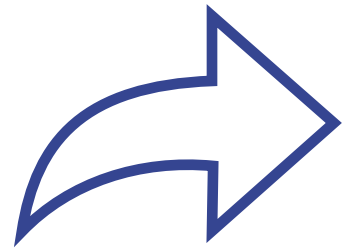

## SCADALite in 3 steps:

- take a photo / develop graphics
- upload to the device
- place the indicators

*and enjoy the functionality!*





## SCADALite

- process management directly from the screen,
- different screens for a single process,
- graphics of the monitored process,
- quick visualization,
- free arrangement of indicators,
- operator's work comfort,
- easy adjustment to specialized requirements,
- quick editing - new graphics and change of indicator arrangement is enough,
- modification of indicator arrangement during the device operation.



## View linking

View linking is used to move directly to the view of a selected group of metering parameters.

Each view created in the SCADALite mode can be now linked to another screen. Just place the magnifying glass button in any location of a specific view and assign the link to the selected group. This function can be used to create multi-level dependencies between view groups, e.g. creating a structure leading from the general application image to sets of detailed parameters.

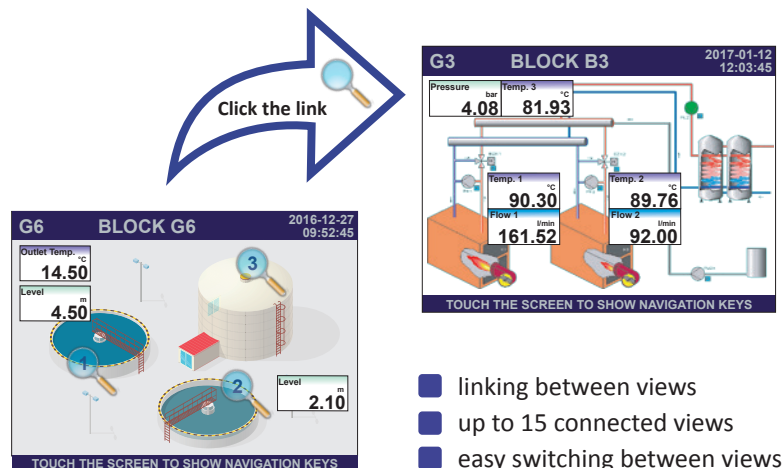

- linking between views
- up to 15 connected views
- easy switching between views

## Parametric screens

Irrespective of the advanced SCADALite data visualization possibilities, the operator may select one of the standard views, according to individual preferences. Depending on whether we need a detailed information on the signal value, quick insight into the signal level, or parameter trend over time, the data can be presented as:

- numerical values,
- quasi-analog indicators,
- phasor charts,
- horizontal or vertical charts,
- horizontal or vertical bars,
- simultaneous presentation of many groups.

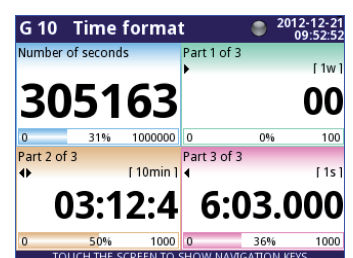
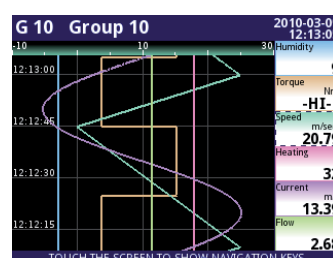
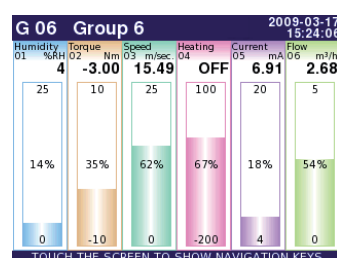
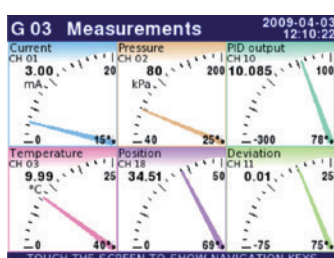

# The expanded functionality

## MultiLevel Access

The **MultiLevel Access** mode makes the DigiCon even more universal. You can define up to 16 independent users including the administrator who is the only user with a permission to freely configure the device without any limitations. The administrator's role also consists in defining permissions for other users. Only one user can be logged on at a given moment. The user is logged off after the lapse of time from the moment of the last interaction of the user with the device as specified by the administrator or upon express request of the user after clicking the padlock icon on the information bar. The authorisation process is additionally facilitated by the possibility of using USB keys. The hardware key allows the user to log on without the necessity of entering a password while removal of the key is equal to logging off. The key is assigned individually to each user. Such a facilitation will be available only for those users whose devices have Access Dongle licence activated. Otherwise the login and logoff process must be carried out manually. The permission file may be saved using external memory and thus it is portable, which highly decreases the configuration time of subsequent units. The hardware key options are available with a DigiCon device having Access Dongle licence activated only.



## HTML5 and widgets

The DigiCon line devices equipped with Ethernet port allow also a very easy remote monitoring of measurement results using a web browser, as well as a very attractive graphical presentation in the form of built-in or user-created websites. Along with the device, the manufacturer supplies a set of built-in visual components which using the HTML5 protocol, provide the programmers with easy mechanisms to retrieve data from the device, as well as ready-to-use formats of data presentation on the computer, tablet or mobile phone screen.

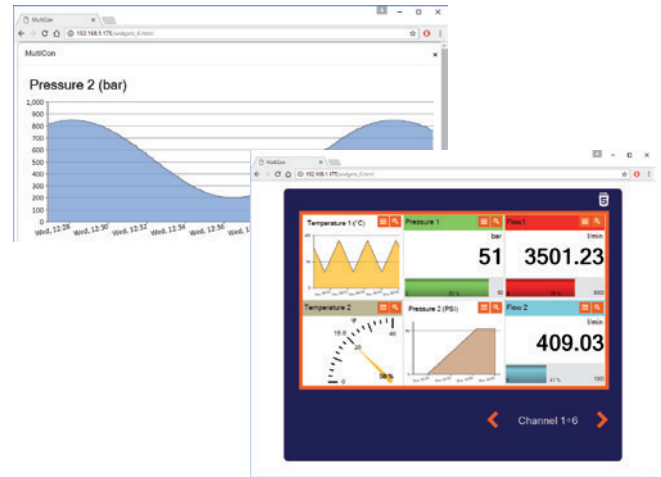

## LookUp Table - user characteristic Tool



The value of every logical channel of DigiCon recorder may be converted using many various methods: by linear scaling, transfer with compliance to the user characteristics. In the case of the letter, each point of the characteristics required manual configuration, what extended the process significantly.

The **LookUp Table** in the user characteristics function is a great tool which allows entering individual points of the characteristics in the form of a csv file, and then importing them to any DigiCon logical channel. Additionally, the edited list may be saved, from the device level, in a new file and used to scale another channel. The new option makes the work on creation of repeatable configurations much more effective and eliminates errors which may occur during manual entry of a large volume of numerical data.



## E-mail notifications

In response to our Customers' demands, the **DigiCon** line devices are now equipped with a brand new function: an “**E-mail notifications**” system. It enables sending e-mails directly from the **DigiCon**, which makes the device even better adapted to high-tech alarm and monitoring systems. The user can define up to 32 different messages to be sent in case of any of the specified events. An e-mail message consists of three elements: topic and text of the message (both with fixed content) and an attachment containing momentary values from the selected groups of or individual measurement channels in the .csv format. Because **DigiCon** supports secure logging (encrypted by TLS or SSL protocol), the account from which notifications are sent can be opened on any e-mail server. The “**E-mail notifications**” system functionality requires the license key.



## Video streaming

One of the benefits of providing the **DigiCon** device with Ethernet port includes video streaming. If the **ETU** or **ACM** communication card operates in the device, it is possible to transfer the image to a Windows computer. It should be directly connected with the device or operate in the same network. Most frequently, this is the plant LAN. After installation of the dedicated Xming software, the screen can be transferred to the computer while maintaining all functionalities of the device. The computer operator will obtain complete **DigiCon** functionality, the same as in the case of direct access. The transferred screen is handled using a cursor under the same principles as in the case of a touch screen or mouse-operated device. This functionality is most often used for:

- ż device configuration,
- ż diagnostics,
- ż saving/loading the configuration file,
- ż previewing the current values.

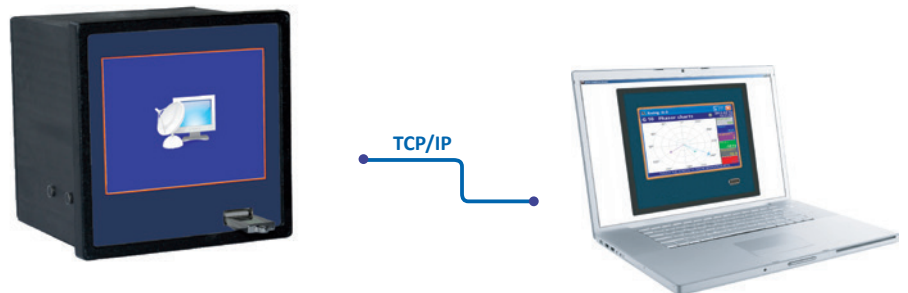

## Communication



Almost every modern electronic measuring instrument is equipped with some type of a communication interface - **DigiCon** has several of them. The primary type of an interface is **USB Host**. It allows you to connect the device not only with a standard mouse and keyboard, but also an external hard drive (e.g. flash) and to download recorded data. More interesting, from the point of view of the communication with the environment, is RS-485 interface with Modbus RTU Protocol available in standard equipment. Like other interfaces, **RS-485** and **RS-232** available in an optional interface module, interface device, each of which can operate independently as Master or Slave at a different transmission speed. Enhanced menu interface allows you to easily configure it, so that **DigiCon** will read data from any device equipped with Modbus RTU, and will control a condition of outputs in it, if it can be remotely controlled.

However **Ethernet interface** gives the greatest possibilities. Built-in Web server, as well as Modbus TCP Protocol give user the possibility to use predefined dynamic data visualizations based on widget applications. If a dedicated process visualization is required, the presented mechanisms can be easily adopted to the individual needs of the customer. Basing on freeware tools for website building available on Web, almost everyone is able to prepare, within few minutes, their own visualizing application, which can be launched almost on every computer connected to the Internet.

For more demanding customers with many needs we have prepared the Advanced Communication Module (ACM). This module includes interfaces such as: Ethernet, USB Host, RS-485 and RS-485 shared with RS-232. This is why DigiCon can offer up to 3 isolated RS-485 interfaces which compose the base for the MultiModbus System. Having such a big number of RS-485 interfaces at your disposal DigiCon can communicate with other devices in several independent networks. All the Modbus interfaces can work in both master and slave mode. By means of an Ethernet link the user can monitor operation of the entire system via the Internet from every place in the world where an Internet browser is within reach. Another way to monitor given data is to use the RS-485 interface along with PC software.

## Some of the applications chosen by our customers:

- central temperature measurement and control system of energetic block,
- control of a multi-zone furnace,
- monitoring system for a pump station,
- multi-point parameters recording of power generators.



# Software

## DAQ Manager

To manage such vast amount of data we have designed the free of charge DAQ Manager software to help you.

The software allows to:

- visualize data in the form of graphs and tables,
- group measurement results,
- create reports,
- export data into other files.

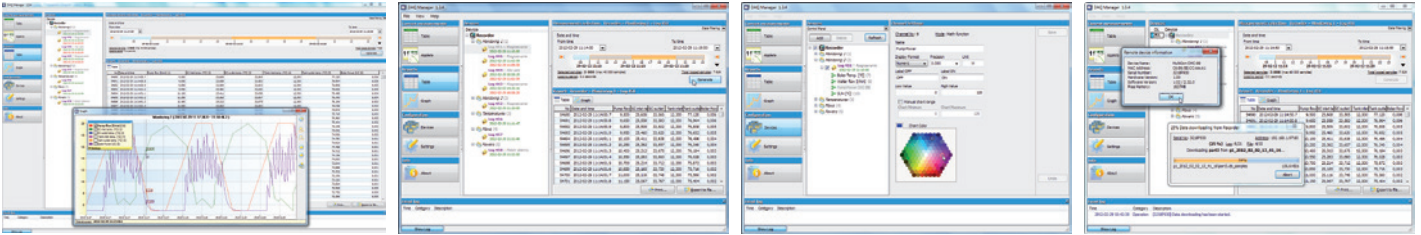

In addition to the data presentation mode (chart/table), the user can also select only the logic channel group concerned. Transparency of presentation will be also enhanced by the change of the time range to such that is important for the analysis being performed. Data and current measurement values recorded by the device can be downloaded automatically or manually by the user. DAQ Manager offers the possibility of creating an individual schedule, in accordance with which data will be downloaded only as selected by it.



Applications in which data recorded by one device are handled by more than one person, or where the data are important in several process points, can be also implemented based on data downloading using the DAQ Manager. Several computers with an installed software can successfully download data from the same DigiCon recorder at the same time.

## Firmware

Thanks to the cooperation with our customers we can continue to develop the software and provide it with new useful functions. Interesting suggestions and needs of our customers have been contributing to better firmware. DigiCon update means three easy steps: download the update free of charge website, send it to a USB flashdrive, start the procedure and it is done.



## DigiCon Emulator

This software allows you to run on the computer screen a virtual DigiCon and familiarize yourselves with its functionality completely free of charge. The DigiCon Emulator is an accurate representation of the actual equipment. In order to test measurement inputs it has been equipped with the virtual measurement and relay output source. A full-featured recording module allows you to write data on the virtual drive and then send them on to a USB flash drive or DAQ Manager directly using TCP protocol.



## DigiCon with thermal printer MultiPrint MLP-149

**DigiCon** data logger has been enhanced to support a thermal printer. Owing to the above, the user has the possibility of generating print-outs of the current measurements directly where the recorder is installed. The print-out consists of three basic parts: the header, the content and the footer. The header and the footer are composed of .PNG image files, which the user may freely prepare and upload to the recorder. The content of the print-out is the part which is generated at the time of printing. It features a table with current measurement results. Additionally, the print-out can include the date and time of printing, which are entered above the table.



- print-out generated directly on-site
- print-out of a table with the current measurement results
- printing on thermal paper and self-adhesive labels
- standard paper width 57 mm
- mini USB communication interface
- print resolution 204 DPI

Your logo

2013-12-06 14:10:17

Heat exchange

Pressure 1	1,00	kPa
Temperature 1	20,5	°C
Flow 1	19	m <sup>3</sup> /h
Pressure 2	100	Pa
Temperature 2	25,8	°C
Flow 2	35	m <sup>3</sup> /h

Burner

Time	22	ms
Consumption	2	kg/h
Temperature	753	°C

Pump

Voltage	130	V
Current	0,2	A
Power	26	W

Editable field

## DigiCon as a power grid analyzer

DigiCon is also suitable in various industries. For some of them, it is extremely important to estimate the consumption of electricity. With counters and grid analysers available in our offer and using a series of mathematical functions implemented, DigiCon is a perfect diagnostic tool. It calculates the balance and current energy consumption easily as well as provides information about common parameters, starting from voltage, intensity, the sum of intensities of three phases, energy and ending with the phase and individual harmonic shifts.

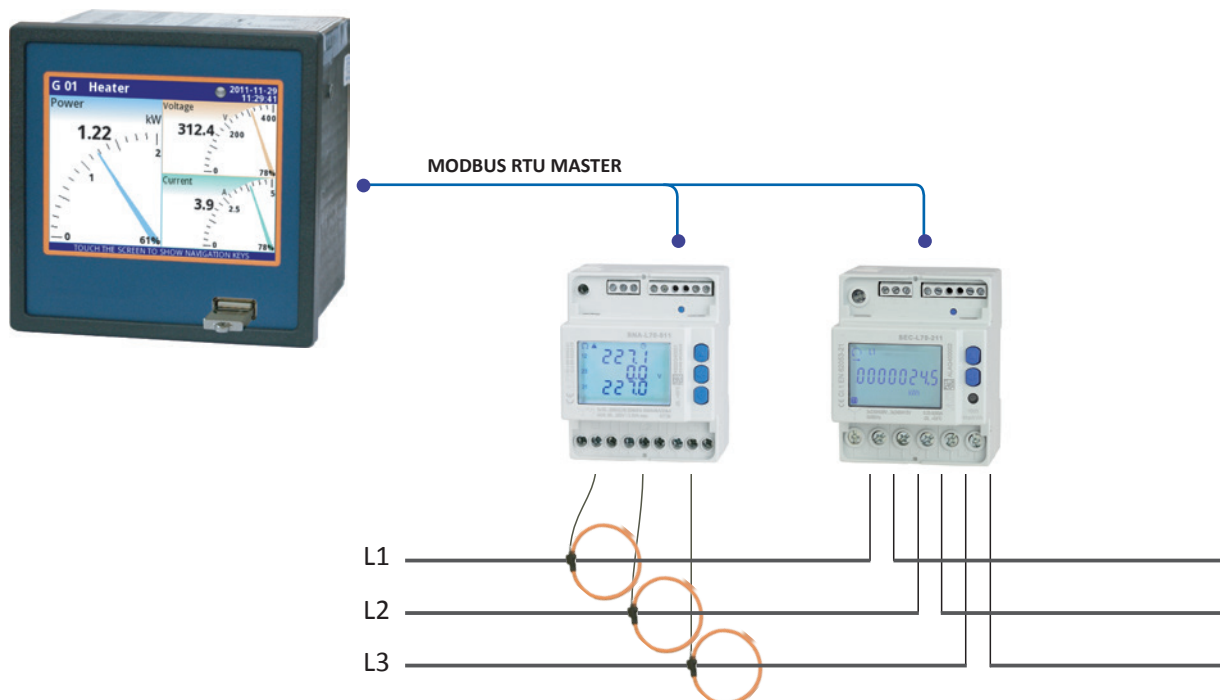

# Special designs

Our offer also includes two interesting and special designs: DigiCon built-in a portable case and panel or in-wall mount DigiCon CMC-99SL.

## DigiCon CMC-99 in a benchtop enclosure with handle

The **DigiCon CMC-99** controller / data recorder may be enclosed in a modern aluminium benchtop mounted enclosure, making it possible to relocate the device using a movable handle. This proves to be a significant advantage as stationary recorders become portable ones, while the features allowing for advanced measurements and recording data collected from the tested plant are still maintained. The enclosure is equipped with all required connectors to tie up measuring sensors and communications systems, i.e. RS-485 and Ethernet.



- advanced aluminium benchtop mounted enclosure with a tilt / swive carry handle
- dimensions (W x H x D): 250 x 150 x 263 mm
- up to 23 input/output/communication connectors

## DigiCon built-in a P130 portable case

Is useful when it is not possible to mount a typical controller/recorder in a safe way. The case is durable and is certified with the IP 67 rate - the device inside is safe. Multi-pin sockets on side walls for connecting sensors and interfaces are designed according to the customer's requirements.



- up to 23 input/output/communication connectors
- colour display with touchscreen, TFT 3.5" or 5.7"
- RS-485 or Ethernet communication
- tight IP 67 case

## Panel or in-wall mount DigiCon CMC-99SL

It's featured by a shallow casing - only 55 mm! All connectors are introduced on side walls of the device as in a typical panel computer. As the number of measurement inputs and outputs is limited, this design is intended mainly for systems with a small number of signals or systems which include other measurement systems with Modbus RTU interface. An Ethernet interface is also available to upgrade every DigiCon control's application easily.

- meter + controller + recorder + HMI in one package
- controller modes: PD, PI, PID, ON/OFF
- designed for shallow mounting, especially inside the machinery
- communication interfaces: Ethernet, RS-485 / Modbus RTU
- 1.5 GB internal memory
- DAQ Manager software for maintenance



	CMC-99	CMC-141	CMC-N16
Power supply/ consumption	19-50V DC, 16-35V AC or 85-260V AC/DC, typ. 15 VA, max. 20 VA	19-50V DC, 16-35V AC or 85-260V AC/DC, typ. 25 VA, max. 35 VA	19-50V DC, 16-35V AC or 85-260V AC/DC, typ. 15 VA, max. 20 VA
Display	3.5" graphic TFT, 16-bit colour, 320 x 240 ppx, touchscreen navigation	5.7" graphic TFT, 16-bit colour, 320 x 240 ppx, touchscreen navigation	3.5" graphic TFT, 16-bit colour, 320 x 240 pxs, touchscreen navigation
Measurement inputs	<ul style="list-style-type: none"> <li>up to 9 universal, isolated: 0/4 ÷ 20 mA; 0/1 ÷ 5V, 0/2 ÷ 10V; thermocouples: J, K, S, T, N, R, B, E (PN-EN), L (GOST); -10 ÷ 25 mV, -10 ÷ 100 mV, 0 ÷ 600 mV; RTD (2/3/4 wire): Pt100, Pt500, Pt1000 (PN-EN), Pt'50, Pt'100, Pt'500 (GOST), Ni100, Ni500, Ni1000 (PN-EN), Cu50, Cu100 (PN-83M-53852), Cu'50, Cu'100 (PN-83M-53852); resistance 0 ÷ 300 Ω, resistance 0 ÷ 3 kΩ</li> <li>up to 48 analogue: 0/4 ÷ 20 mA, 0/1 ÷ 5V, 0/2 ÷ 10V</li> <li>up to 24 thermocouples: J, K, S, T, N, R, B, E (PN-EN); L (GOST); ± 25 mV, ± 100 mV, -10 ÷ 25 mV, -10 ÷ 100 mV</li> <li>up to 12 RTD: Pt100, Pt500, Pt1000 (PN-EN); Pt'50, Pt'100, Pt'500 (GOST); Ni100, Ni500, Ni1000 (PN-EN); Cu50, Cu100 (PN-83M-53852); Cu'50, Cu'100 (PN-83M-53852); resistance 0 ÷ 300 Ω, resistance 0 ÷ 3 kΩ</li> <li>up to 24 NTC: 0 ÷ 110 kΩ</li> <li>up to 12 counters: max. freq. 5 kHz</li> <li>up to 12 digital flowmeter / ratemeter: max. freq. 50 kHz</li> <li>up to 12 analogue flowmeter: 0/4 ÷ 20 mA</li> <li>mixed inputs: analogue-NTC temperature or analogue-digital: up to 12 x 0 ÷ 20 mA, 4 ÷ 20 mA and up to 12 x 0 ÷ 5V, 1 ÷ 5V, 0 ÷ 10V, 2 ÷ 10V and up to 24 x NTC or digital</li> </ul>	<ul style="list-style-type: none"> <li>up to 15 universal, isolated: 0/4 ÷ 20 mA; 0/1 ÷ 5V, 0/2 ÷ 10V; thermocouples: J, K, S, T, N, R, B, E (PN-EN), L (GOST); -10 ÷ 25 mV, -10 ÷ 100 mV, 0 ÷ 600 mV; RTD (2/3/4 wire): Pt100, Pt500, Pt1000 (PN-EN), Pt'50, Pt'100, Pt'500 (GOST), Ni100, Ni500, Ni1000 (PN-EN), Cu50, Cu100 (PN-83M-53852), Cu'50, Cu'100 (PN-83M-53852); resistance 0 ÷ 300 Ω, resistance 0 ÷ 3 kΩ</li> <li>up to 72 analogue: 0/4 ÷ 20 mA, 0/1 ÷ 5V, 0/2 ÷ 10V</li> <li>up to 36 thermocouples: J, K, S, T, N, R, B, E (PN-EN); L (GOST); ± 25 mV, ± 100 mV, -10 ÷ 25 mV, -10 ÷ 100 mV</li> <li>up to 18 RTD: Pt100, Pt500, Pt1000 (PN-EN); Pt'50, Pt'100, Pt'500 (GOST); Ni100, Ni500, Ni1000 (PN-EN); Cu50, Cu100 (PN-83M-53852); Cu'50, Cu'100 (PN-83M-53852); resistance 0 ÷ 300 Ω, resistance 0 ÷ 3 kΩ</li> <li>up to 24 NTC: 0 ÷ 110 kΩ</li> <li>up to 12 counters: max. freq. 5 kHz</li> <li>up to 12 digital flowmeter / ratemeter: max. freq. 50 kHz</li> <li>up to 12 analogue flowmeter: 0/4 ÷ 20 mA</li> <li>mixed inputs: analogue-NTC temperature or analogue-digital: up to 24 x 0 ÷ 20 mA, 4 ÷ 20 mA and up to 24 x 0 ÷ 5V, 1 ÷ 5V, 0 ÷ 10V, 2 ÷ 10V and up to 24 x NTC or digital</li> </ul>	<ul style="list-style-type: none"> <li>2 or 4 universal, isolated: 0/4 ÷ 20 mA (also totalizer mode); 0/1 ÷ 5V, 0/2 ÷ 10V; thermocouples: J, K, S, T, N, R, B, E (PN-EN), L (GOST); -10 ÷ 25 mV, -10 ÷ 100 mV, 0 ÷ 600 mV; RTD (2/3 wire): Pt100, Pt500, Pt1000 (PN-EN), Pt'50, Pt'100, Pt'500 (GOST), Ni100, Ni500, Ni1000 (PN-EN), Cu50, Cu100 (PN-83M-53852), Cu'50, Cu'100 (PN-83M-53852); resistance 0 ÷ 300 Ω, resistance 0 ÷ 3 kΩ</li> <li>2 universal pulse counter / ratemeter (max. freq. 5 kHz)</li> </ul>
Digital inputs	<ul style="list-style-type: none"> <li>up to 49 *</li> </ul>	<ul style="list-style-type: none"> <li>up to 73 *</li> </ul>	<ul style="list-style-type: none"> <li>up to 5 *</li> </ul>
Outputs	<ul style="list-style-type: none"> <li>up to 8 analogue 4 ÷ 20 mA, passive, isolated, resolution 12 bit</li> <li>up to 16 SPST relay 1A/250V</li> <li>up to 4 SPDT relay 5A/250V</li> <li>up to 48 SSR</li> </ul>	<ul style="list-style-type: none"> <li>up to 24 analogue 4 ÷ 20 mA, passive, isolated, resolution 12 bit</li> <li>up to 36 SPST relay 1A/250V</li> <li>up to 18 SPDT relay 5A/250V</li> <li>up to 72 SSR</li> </ul>	<ul style="list-style-type: none"> <li>2 or 4 analogue 4 ÷ 20 mA, passive, isolated, resolution 14 bit</li> <li>2 or 4 SPST relay 1A/250V</li> <li>2 or 4 SSR passive (OC with PWM)</li> <li>mixed outputs: 2 x REL / 2 x 4 ÷ 20 mA, 2 x REL / 2 x SSR passive, 2 x 4 ÷ 20 mA / 2 x SSR</li> </ul>
Sensor supply output	• 1 x 24V DC ±5%, 200 mA max.	• 1 x 24V DC ±5%, 200 mA max.	• 1 x 24V DC ±5%, 200 mA max.
Communication interface	<b>Basic version:</b> RS-485, 1 x USB Host, ETU: 1 or 2 x USB Host, 1 x Ethernet <b>ACM:</b> 2 x RS-485, 1 x RS-485/232, 1 or 2 x USB Host, 1 x Ethernet	<b>Basic version:</b> RS-485, 1 x USB Host, ETU: 1 or 2 x USB Host, 1 x Ethernet <b>ACM:</b> 2 x RS-485, 1 x RS-485/232, 1 or 2 x USB Host, 1 x Ethernet	<b>Basic version:</b> RS-485, 1 x USB Host <b>ETE:</b> 1 x Ethernet wired via gland to RJ45 built-in connector <b>ETEC:</b> 1 x Ethernet wired to M12 connector <b>ETR:</b> 1 x Ethernet wired via gland to RJ45 built-in connector + 2nd RS-485 port <b>ETRC:</b> 1 x Ethernet wired to M12 connector + 2nd RS-485 port
Protocols	Modbus RTU Master or Slave, Modbus TCP Server, HTTP, Web Server	Modbus RTU Master or Slave, Modbus TCP Server, HTTP, Web Server	Modbus RTU Master or Slave, Modbus TCP Server, HTTP, Web Server
IP rate protection	IP 65 or IP 40 (version with front USB), options: frame IP 65 for panel cut-out sealing and transparent door with key (IP 54)	IP 65 or IP 40 (version with front USB), options: frame IP 65 for panel cut-out sealing and transparent door with key (IP 54)	IP 65
Operating temp. Storage temp.	0°C ÷ +50°C (optional -20°C ÷ +50°C) -10°C ÷ +70°C (optional -20°C ÷ +70°C)	0°C ÷ +50°C (optional -20°C ÷ +50°C) -10°C ÷ +70°C (optional -20°C ÷ +70°C)	0°C ÷ +50°C (optional -20°C ÷ +50°C) -10°C ÷ +70°C (optional -20°C ÷ +70°C)
Data memory Data recording speed	internal 1.5 GB from 0.1 s to 24 h with resolution 0.1 s	internal 1.5 GB from 0.1 s to 24 h with resolution 0.1 s	internal 1.5 GB from 0.1 s to 24 h with resolution 0.1 s
Dimensions	case (WxHxD): 96 x 96 x 100 mm panel cut-out: 90.5 x 90.5 mm installation depth: min. 102 mm panel thickness: standard 7 mm or other depending on used board thickness brackets	case (WxHxD): 144 x 144 x 100 mm panel cut-out: 137 x 137 mm installation depth: min. 102 mm panel thickness: standard 7 mm or other depending on used board thickness brackets	case (WxHxD): 166 x 161 x 103 mm (without glands) 166 x 191 x 103 mm (with glands) wall mounted

\* one digital input is available in standard, integrated on PS32 or PS42 power supply.



# CMC-99/141 Ordering

## DigiCon CMC-XX-P/D/C/B/A-XXX

### version:

99 : 96 x 96 mm case  
141 : 144 x 144 mm case

slot P - power supply module

slot D - communication module

slot A - I/O module

slot B - I/O module

slot C - I/O module

available modules listed below

### options:

- 001: no options
- 00C: PCB conformal coating
- 011: IP 65 frame
- 01C: IP 65 frame + PCB conformal coating
- 081: operating temp. -20°C ÷ +50°C  
+ PCB conformal coating
- 0B1: front USB Host (IP 40)
- 0BC: front USB Host (IP 40) + PCB conformal coating
- 0P1: IP 65 + operating temp. -20°C ÷ +50°C  
+ PCB conformal coating
- 0K1: front USB Host (IP 40) + operating temp. -20°C ÷ +50°C  
+ PCB conformal coating

- Optional:** LKS-99/141 Data logging licence key  
MLS-99/141 MultiLevel Access licence key  
ENS-99/141 „E-mail notifications“ licence key  
SLS-99/141 „SCADALite“ licence key

Module type	Description	DigiCon CMC-99					DigiCon CMC-141				
		P	D	C	B	A	P	D	C	B	A
PS32	power supply 19 ÷ 50V DC, 16 ÷ 35V AC	•					•				
PS42	power supply 85 ÷ 260V AC/DC	•					•				
E	no communication module (available for 0B option only)		•				•				
ETU	communication module: 1 x USB Host, 1 x Ethernet 10 Mb/s		•				•				
ACM	advanced communication module: 1 x RS-485, 1 x RS-485/232, 1 x USB Host, 1 x Ethernet 10 Mb/s		•				•				
USB	USB port (back)		•				•				
E	empty slot			•	•	•		•	•	•	
UN3	3 x universal inputs U/I/RTD/TC/mV, isolated			•	•	•		•	•	•	
UN5	5 x universal inputs U/I/RTD/TC/mV, isolated							•	•	•	
I16	16 x current inputs			•	•	•		•	•	•	
I24	24 x current inputs							•	•	•	
IS6	6 x current (4 ÷ 20 mA) inputs, isolated			•	•	•		•	•	•	
U16	16 x voltage inputs			•	•	•		•	•	•	
U24	24 x voltage inputs							•	•	•	
UI4	4 x voltage inputs + 4 x current inputs			•	•	•		•	•	•	
UI8	8 x voltage inputs + 8 x current inputs			•	•	•		•	•	•	
UI12	12 x voltage inputs + 12 x current inputs							•	•	•	
UI4N8	4 x voltage inputs + 4 x current inputs + 8 x NTC inputs			•	•	•		•	•	•	
UI4D8	4 x voltage inputs + 4 x current inputs + 8 x digital inputs			•	•	•		•	•	•	
UI8N8	8 x voltage inputs + 8 x current inputs + 8 x NTC inputs							•	•	•	
UI8D8	8 x voltage inputs + 8 x current inputs + 8 x digital inputs							•	•	•	
RT4	4 x RTD inputs			•	•	•		•	•	•	
RT6	6 x RTD inputs							•	•	•	
TC4	4 x TC inputs			•	•	•		•	•	•	
TC8	8 x TC inputs			•	•	•		•	•	•	
TC12	12 x TC inputs							•	•	•	
D8	8 x digital inputs, isolated			•	•	•		•	•	•	
D16	16 x digital inputs, isolated			•	•	•		•	•	•	
D24	24 x digital inputs, isolated							•	•	•	
CP2	2 x pulse inputs, universal counters, isolated			•	•	•		•	•	•	
CP4	4 x pulse inputs, universal counters, isolated			•	•	•		•	•	•	
HM2	2 x hourmeters, isolated			•	•	•		•	•	•	
HM4	4 x hourmeters, isolated			•	•	•		•	•	•	
FT2	2 x pulse inputs (flowmeter/ratemeter), isolated + 2 x current inputs			•	•	•		•	•	•	
FT4	4 x pulse inputs (flowmeter/ratemeter), isolated + 4 x current inputs			•	•	•		•	•	•	
FI2	2 x current inputs (flowmeter/ratemeter) + 2 x current inputs			•	•	•		•	•	•	
FI4	4 x current inputs (flowmeter/ratemeter) + 4 x current inputs			•	•	•		•	•	•	
R81	8 x SPST relay 1A outputs			•	•*			•	•	•	
R121	12 x SPST relay 1A outputs							•	•	•	
R45	4 x SPDT relay 5A outputs			•				•	•	•	
R65	6 x SPDT relay 5A outputs							•	•	•	
S8	8 x SSR driver outputs			•	•	•		•	•	•	
S16	16 x SSR driver outputs			•	•	•		•	•	•	
S24	24 x SSR driver outputs							•	•	•	
IO2	2 x 4 ÷ 20 mA outputs, isolated			•	•			•	•	•	
IO4	4 x 4 ÷ 20 mA outputs, isolated			•	•			•	•	•	
IO6	6 x 4 ÷ 20 mA outputs, isolated							•	•	•	
IO8	8 x 4 ÷ 20 mA outputs, isolated							•	•	•	

\* The installation of the R81 module in slot B only in the case where in the slot C another relay module (R81 or R45) was installed.

## DigiCon CMC-N16-P/D/C/B/A-XXX

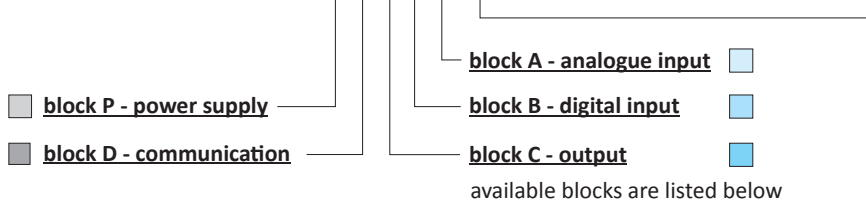

### options:

- 0B1:** no options
- 0BC:** PCB conformal coating
- OK1:** operating temperature -20°C ÷ +50°C including PCB conformal coating

available blocks are listed below

- Optional:** LKS-99/141 Data logging licence key  
 MLS-99/141 MultiLevel Access licence key  
 ENS-99/141 „E-mail notifications” licence key  
 SLS-99/141 „SCADALite” licence key

Block type	Port usage (pu)*	Block description
<b>Block P - power supply</b>		
PS3	0	19 ÷ 50V DC, 16 ÷ 35V AC power supply
PS4	0	85 ÷ 260V AC/DC power supply
<b>Block D - communication</b>		
E	0	Empty
ETE	1	Ethernet wired via gland to RJ45 built-in connector
ETEC	1	Ethernet wired to M12 connector
ETR	2	Ethernet wired via gland to RJ45 built-in connector + second RS-485 port
ETRC	2	Ethernet wired to M12 connector + second RS-485 port
<b>Block C - output</b>		
E	0	Empty
R21	2	2 x SPST relay 1A/250V output
R41	4	4 x SPST relay 1A/250V output
COP2	2	2 x 4 ÷ 20 mA output, passive, isolated
COP4	4	4 x 4 ÷ 20 mA output, passive, isolated
OC2	2	2 x SSR output, passive (OC with PWM)
OC4	4	4 x SSR output, passive (OC with PWM)
R21COP2	4	2 x SPST relay 1A/250V output + 2 x 4 ÷ 20 mA output, passive, isolated
R21OC2	4	2 x SPST relay 1A/250V output + 2 x SSR output, passive (OC with PWM)
COP2OC2	4	2 x 4 ÷ 20 mA output, passive, isolated + 2 x SSR output, passive (OC with PWM)
<b>Block B - digital input</b>		
E	0	Empty
DU2	2	2 x universal pulse counter/ratemeter input or 4 x digital input
D4	4	4 x digital input
<b>Block A - analogue input</b>		
E	0	Empty
FUN2	2	2 x universal input (also totalizer on 0/4 ÷ 20 mA input), isolated
FUN4	4	4 x universal input (also totalizer on 0/4 ÷ 20 mA input), isolated

\* Note: maximum port usage is 10, one option per each block only, total „pu” acceptable is  $D+C+B+A < or = 10$ .

### Glands lay-out:

- pu 0-1:** 1 x M25 + 1 x M16
- pu 2-5:** 2 x M25 + 1 x M16
- pu 6-10:** 3 x M25 + 1 x M16

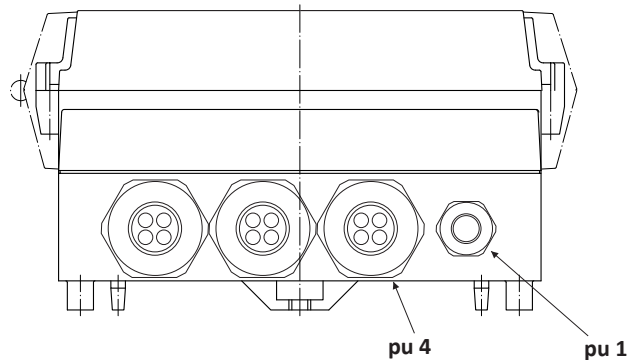

### Cable diameter for glands:

- M25:** 1 x 13-18 mm or 3 x 7 mm or 4 x 6 mm (adaptors included)
- M16:** 1 x 4-8 mm or M12 Ethernet connector (refers to ETEC and ETRC communication block)

### Ordering examples:

- CMC-N16-PS4/ETE/R21/DU2/FUN4-0B1
- CMC-N16-PS3/ETR/E/E/E-0B1

# Accessories

<p><b>STD-99, STD-141</b></p>	<p>A transparent door with IP 54 rate and a key. The door and its frame are manufactured using the injection moulding technology which ensures that they fit perfectly. The material has been selected to eliminate corrosion and ensure maximum durability.</p>	
<p><b>SRH-99, SRH-141</b></p>	<p>Assembly brackets for installation of the DigiCon e.g. in control cabinets with typical 35 mm bus bars.</p>	
<p><b>DAQ Manager</b></p>	<p>Software for managing the recorded data. Its fully functional and free of charge version can be downloaded from our website or ordered as a payable CD-ROM version.</p>	
<p><b>Board thickness brackets</b></p>	<p><b>SPH-07:</b> 1 ÷ 7 mm board thickness brackets (2 pcs) <b>standard included with device</b></p> <p><b>SPH-05:</b> 1 ÷ 5 mm board thickness brackets (2 pcs)</p> <p><b>SPH-45:</b> 1 ÷ 45 mm board thickness brackets (2 pcs)</p>	
<p><b>Pendrive</b></p>	<p>An unusually small and light USB flashdrive has been designed with easy storage and transport in mind. <b>MF</b> fits perfectly the DigiCon controller's casing with closed IP 54 rate door.</p> <p><b>MF-8</b> : mini pendrive / memory stick, <b>8 GB</b> + strap</p> <p><b>UF-8</b> : DigiCon <b>8 GB</b> USB flash drive / give away USB memory</p>	
<p><b>Licence keys</b></p>	<p><b>SLS-99/141:</b> SCADALite licence key  <b>LKS-99/141:</b> Data logging licence key  <b>ENS-99/141:</b> E-mail notifications licence key  <b>MLS-99/141:</b> MultiLevel Access licence key</p> <p>Also available 30 day, free trial versions of licence keys.</p>	 <p style="text-align: center;">Licence Key to activate recording functions on the Data Logger</p> <p style="text-align: center;">S/N: 3523P1026 Data Logger Key 103-80253-115-40851</p> <ul style="list-style-type: none"> <li>• In order to start using data logging functions, you need to enter the above software licence key.</li> <li>• Each licence key is individual and refers to device serial number.</li> <li>• Just use "Enter licence key" option in your data logger "Device information" menu.</li> <li>• Enjoy this powerful data recording functionality!</li> </ul>
<p><b>SCL-N16</b></p>	<p>CMC-N16 case lock</p>	





Digitron Italia S.r.l.  
Via ASI Consortile, n° 7  
03013 Ferentino (FR)  
Italia  
Tel (+39) 0775 392052  
Fax (+39) 0775 223835  
[www.digitron-italia.com](http://www.digitron-italia.com)  
[info@digitron-italia.it](mailto:info@digitron-italia.it)

